

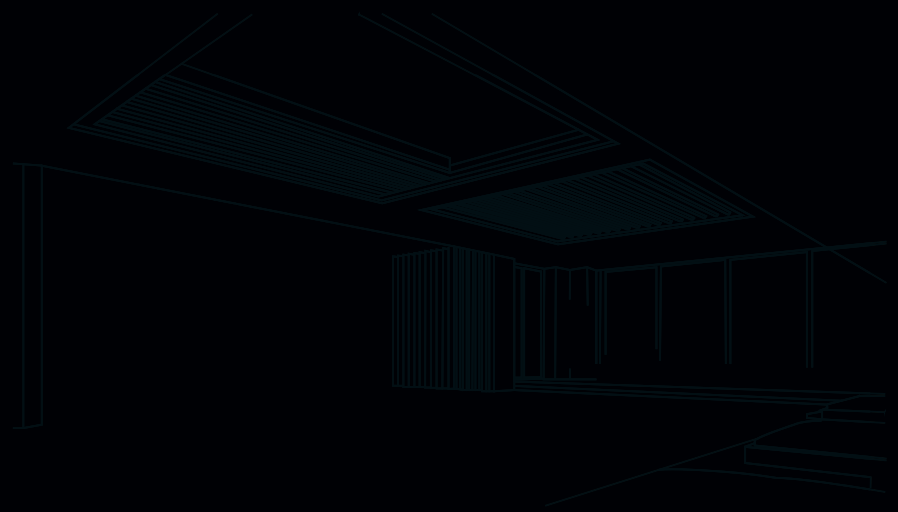

FBM ALÜMİNYUM BALKON DÜNYASI



Ürün Kataloğu  
Product Catalogue

# RÜZGAR KIRICI / WINDBREAKER

Rüzgâr Kırıcı Sistemleri, otel, kafe, restoran, konut, teras, alışveriş merkezleri gibi mekânlarda rüzgârın olumsuz etkilerinden korunmanızı sağlayarak yaşam alanlarınızı daha konforlu ve vazgeçilmez hale getirir. Rüzgar Kırıcı Sistem; rüzgârlı havalarda hava akışını oturma seviyesinden yukarıya taşıyarak rüzgârın olumsuz etkilerini azaltır.

Hareketli cam panel yer seviyesinden 180 cm yüksekliğe kadar rüzgârdan korur.

Sistem manuel olarak kullanıma uygundur. Ağırlık dengeleme sistemi sayesinde yükseklik ayarı kolaylıkla yapılabilmektedir.

Rüzgâr Kırıcı, tek başına kullanılabilirdiği gibi yan yana getirilerek de kullanılabilir ve açık alanlarda seperatör görevini üstlenir. Kafe ve restoran gibi işletmelerde masa arasında kullanılan Rüzgar Kırıcı, COVID-19'un bulaşma etkisini azaltabilir.

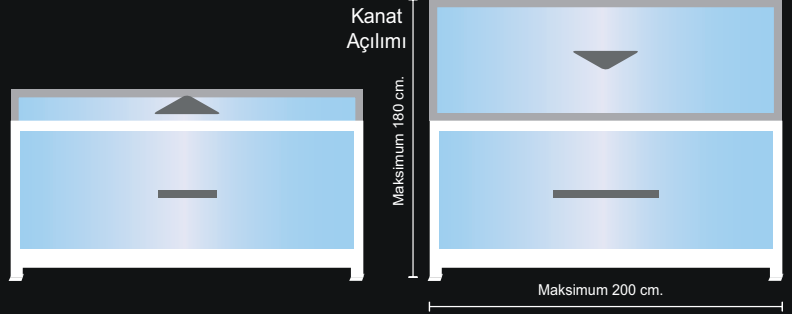

Wind Breaker Systems make living spaces more comfortable and indispensable by protecting you from the negative effects of wind in places such as hotels, cafes, restaurants, residences, terraces and shopping centers. The Wind Breaker System reduces the negative effects of the wind by moving the air flow above the session level in windy weather.

The movable glass panel protects from the wind up to 180 cm above ground level.

The system is suitable for manual use. Height adjustment can be made easily with the weight balancing system.

The Wind Breaker can be used alone or side by side and acts as a separator in open areas. The Wind Breaker, which is used between the tables in businesses such as cafes and restaurants, can reduce the contagion effect of COVID-19.

# Rüzgar Kırıcı (MANUEL)

## Windbreaker

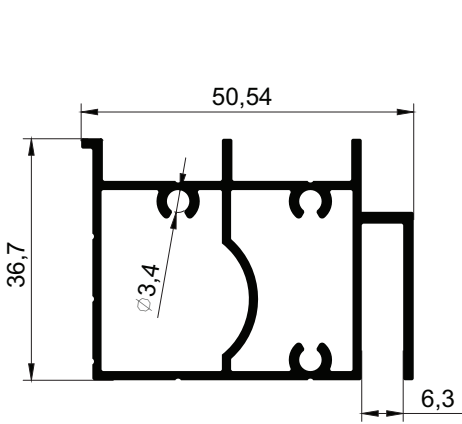

**RK-501 DİKEY BAZA**  
0.946 kg/m

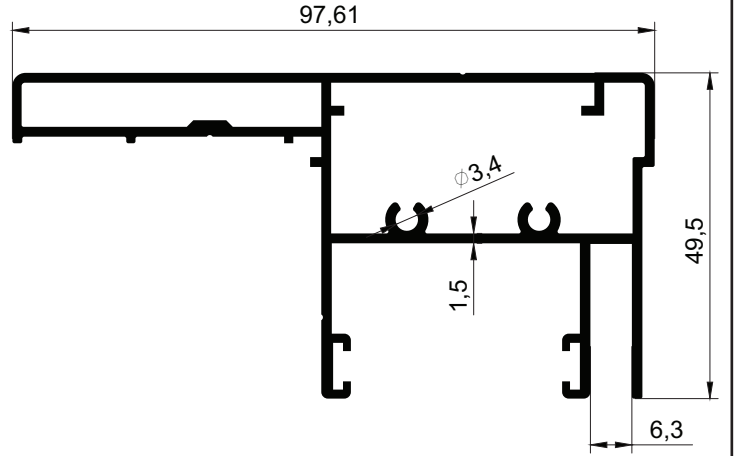

**RK-502 SABİT DİKME**  
1.526 kg/m

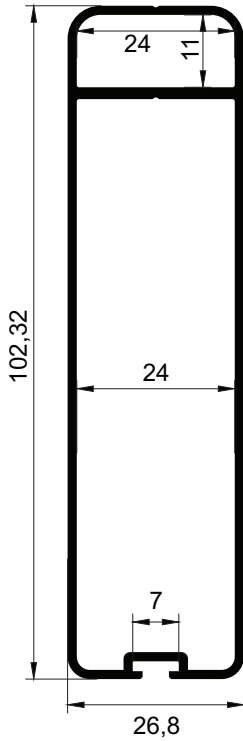

**RK-504 AĞIRLIK**  
1,08 kg/m

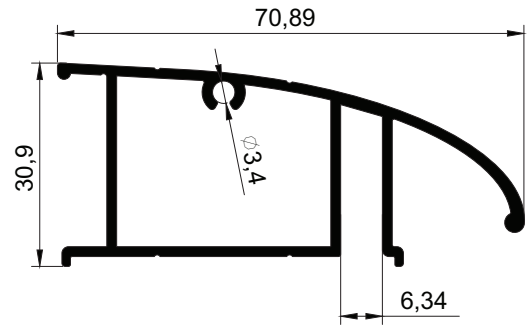

**RK-503 KÜPEŞTE**  
0.806 kg/m

**Not: Ağırlık Profili için 2 adet 20x10 Lama ve 20x10 silme demir kullanılır.**

**UYARI!** Alüminyum profillerin, yukarıda belirtilen birim ağırlıkları yaklaşık olarak hesaplanmıştır. Gerçek birim ağırlıkları, teslimat sırasında yapılan tartım işlemi sonucuna göre hesaplanacaktır.  
**WARNING!** Above mentioned aluminium profiles unit weights have been theoretically calculated. The actual unit weight will be calculated on delivery to put into the invoicing process.

# Rüzgar Kırıcı (**MANUEL/PİSTONLU**) Aksesuar Seti

## Accessories

(RKA-SET-1) Aksesuar/Ürün	Açıklama	Birim	Miktar	Kod	
	Üst Hareketli Kapak	Sağ ve Sol Plastik	Adet	2	RKA-201
	2 mm Çelik Tel Halat	Tek Tip Çelik	Adet 1,25 mt	2	RKA-202
	Halat Yüzük	Tek Tip Çelik	Adet	4	RKA-203
	Üst Sabit Kapak	Sağ ve Sol Plastik	Adet	2	RKA-204
	Ayak	Sağ ve Sol Çelik	Adet	2	RKA-205
	Hareketli Kızak	Tek Tip Plastik	Adet	4	RKA-206
	Halat Makarası	Tek Tip Çelik	Adet	2	RKA-207
	Fren	Tek Tip Çelik	Adet	2	RKA-204

**UYARI!** Alüminyum profillerin, yukarıda belirtilen birim ağırlıkları yaklaşık olarak hesaplanmıştır. Gerçek birim ağırlıkları, teslimat sırasında yapılan tartım işlemi sonucuna göre hesaplanacaktır.  
**WARNING!** Above mentioned aluminium profiles unit weights have been theoretically calculated. The actual unit weight will be calculated on delivery to put into the invoicing process.

# Rüzgar Kırıcı (PİSTONLU)

## Windbreaker

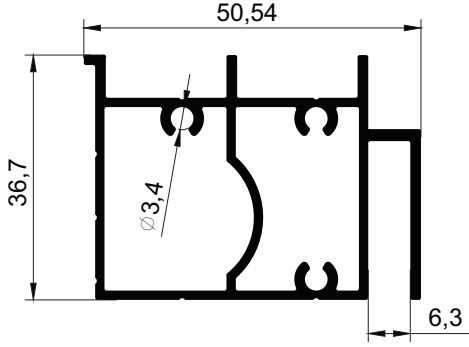

**RK-501 DİKEY BAZA**  
0.946 kg/m

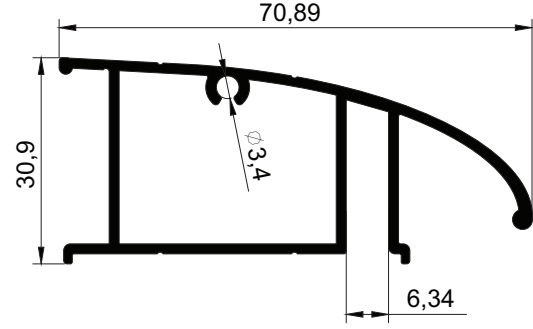

**RK-503 KÜPEŞTE**  
0.806 kg/m

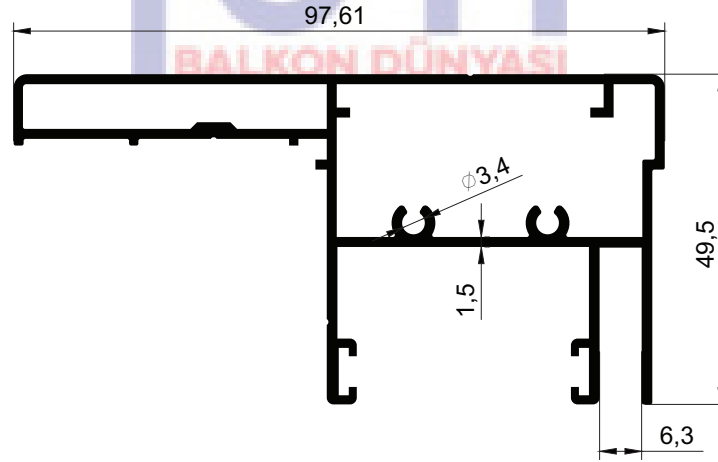





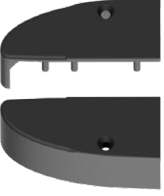

**RK-502 SABİT DİKME**  
1.526 kg/m

**UYARI!** Alüminyum profillerin, yukarıda belirtilen birim ağırlıkları yaklaşık olarak hesaplanmıştır. Gerçek birim ağırlıkları, teslimat sırasında yapılan tartım işlemi sonucuna göre hesaplanacaktır.  
**WARNING!** Above mentioned aluminium profiles unit weights have been theoretically calculated. The actual unit weight will be calculated on delivery to put into the invoicing process.

# Rüzgar Kırıcı (**PİSTONLU**) Aksesuar Seti

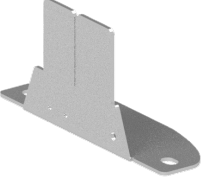
## Accessories

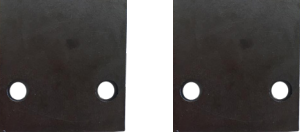
(RKA-SET-1) Aksesuar/Ürün	Açıklama	Birim	Miktar	Kod	
	Üst Hareketli Kapak	Sağ ve Sol Plastik	Adet	2	RKA-201
	Piston Sabitleme Lazeri	Tek Tip Çelik	Adet	2	RKA-212
	Piston	Tek Tip Çelik	Adet	2	RKA-213
	Üst Sabit Kapak	Sağ ve Sol Plastik	Adet	2	RKA-204
	Ayak	Sağ ve Sol Çelik	Adet	2	RKA-205
	Hareketli Kızak	Tek Tip Plastik	Adet	4	RKA-206
	Fren	Tek Tip Çelik	Adet	2	RKA-204

**UYARI!** Alüminyum profillerin, yukarıda belirtilen birim ağırlıkları yaklaşık olarak hesaplanmıştır. Gerçek birim ağırlıkları, teslimat sırasında yapılan tartım işlemi sonucuna göre hesaplanacaktır.  
**WARNING!** Above mentioned aluminium profiles unit weights have been theoretically calculated. The actual unit weight will be calculated on delivery to put into the invoicing process.

# Rüzgar Kırıcı (MOTORLU)

## Windbreaker

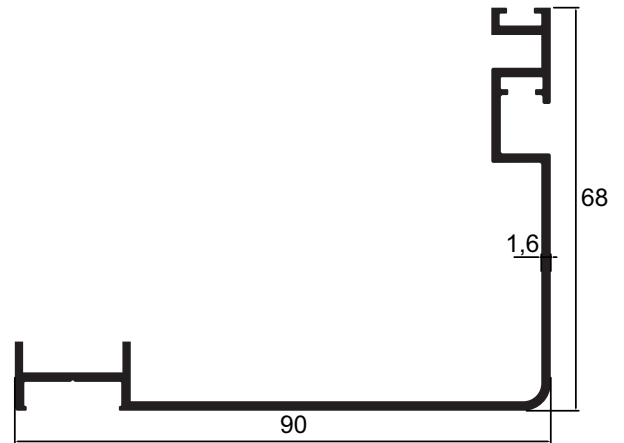
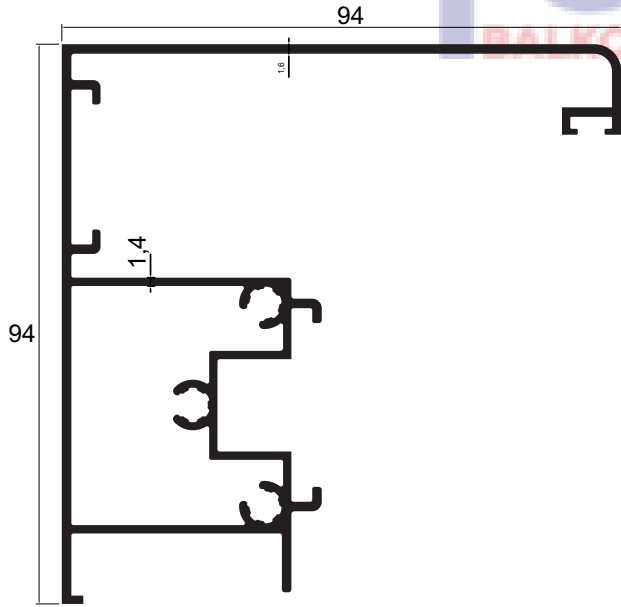
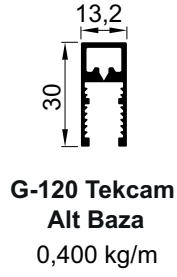
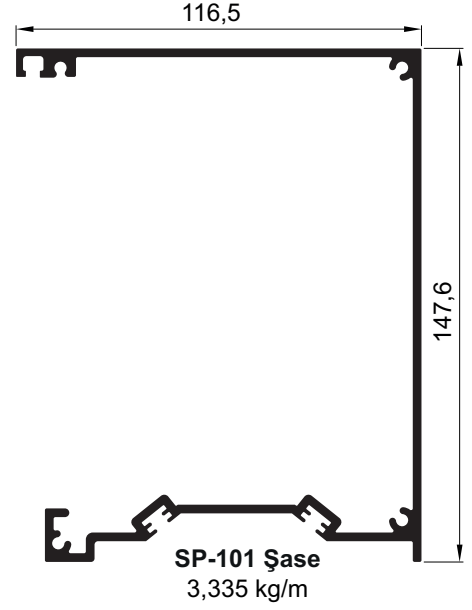
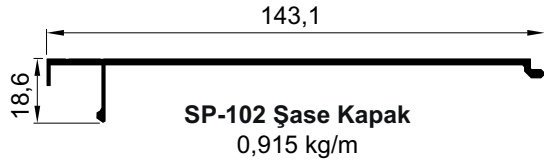

**UYARI!** Alüminyum profillerin, yukarıda belirtilen birim ağırlıkları yaklaşık olarak hesaplanmıştır. Gerçek birim ağırlıkları, teslimat sırasında yapılan tartım işlemi sonucuna göre hesaplanacaktır.  
**WARNING!** Above mentioned aluminium profiles unit weights have been theoretically calculated. The actual unit weight will be calculated on delivery to put into the invoicing process.

# Rüzgar Kırıcı (MOTORLU) Aksesuar Seti

## Accessories

(RKA-SET-3) Aksesuar/Ürün	Açıklama	Birim	Miktar	Kod	
	Rüzgar Kırıcı Makara	Plastik ve Çelik	Adet	2	RKA-15
	Rüzgar Kırıcı Cam Tutucu Vantuz	Tek Tip Plastik	Adet	4	RKA-16
	Rüzgar Kırıcı Cam Tutucu	Tek Tip Çelik	Adet	2	RKA-17
	Dikme Alt Kapak	Sağ ve Sol Plastik	Adet	2	RKA-18
	Dikme Üst Kapak	Sağ ve Sol Çelik	Adet	2	RKA-19
	Rüzgar Kırıcı Cam Kızaklama	Tek Tip Plastik	Adet	2	RKA-20
	Gergi Tamburu	Tek Tip Çelik	Adet	2	RKA-21
	Rüzgar Kırıcı Makara Tablası	Tek Tip Çelik	Adet	2	RKA-22
	Kayış Tamburu	Tek Tip plastik	Adet	2	GA-12
	Boru Başı	Tek Tip Alüminyum	Adet	1	GA-04
	Şase Kapak	Sağ ve Sol Plastik	Adet	2	GA-05
	Şase Kapak Rulman Yatak	Rulmanlı Plastik	Adet	1	GA-06
	Ayak	Sağ ve Sol Çelik	Adet	2	RKA-23

# GIYOTINLI CAM SİSTEMLERİ

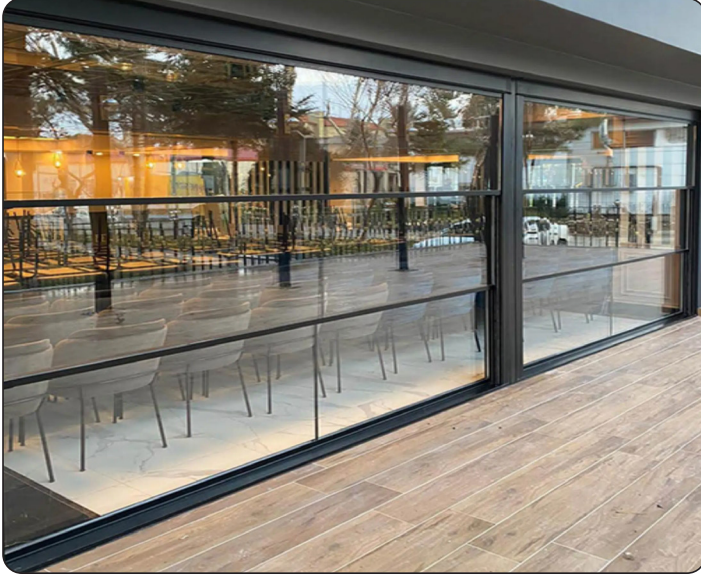

Giyotin Cam Sistemleri; gelişmiş teknolojisi ve fonksiyonel özellikleri ile otel, kafe, restoran, konut, teras, kış/yaz bahçesi, alışveriş merkezleri gibi yaşam alanlarını daha konforlu ve vazgeçilmez hale getirir. Firma olarak siz değerli müşterilerimize; ilkbahar, sonbahar veya kışın tadını; soğuk, yağmur suyu veya kar olmadan daha ferah, daha geniş, daha aydınlık dolayısıyla daha fazla keyif alabileceğiniz dört mevsim yaşam alanları sunuyoruz.

## TASARIM VE FONKSİYONELLİK

• Giyotin Cam Sistemleri, 8mm temperli (kırılmaya dayanıklı) veya ısıcam panellerin motor yardımıyla yukarı/aşağı hareket etmesiyle, panoramik görüş açısı ve gün ışığının içeri girmesiyle doğal aydınlatma sağlar.

- RTS teknolojisi kullanan giyotin sistem motoru uzaktan kumanda ile çalışır ve start-stop teknolojisi sayesinde hareket istenildiği noktada durdurulabilir.
- Sistemin tamamı veya tek bir modülü uzaktan kumanda ile çalıştırılabilir.
- Estetiği ve görüş alanını minimum oranda etkileyen cam profilleri, kullanıcıların görüş alanını engellemez ve sınırsız renk, ahşap kaplama ve desen seçenekleri ile dış ortam ile kusursuz bir bütünlük sağlar.
- Sisteme eklenebilen yağmur ve rüzgâr sensörleri, sistem açık durumdayken yağış ve fırtına gibi durumları algılar ve otomatik kapanır.
- Giyotin sistemler % 60 oranında ses yalıtımı sağlamakta, ısıcamlı sistemlerde kullanılabilen sinerji ve konfor camlar ile ısı yalıtım özelliği daha da üst seviyelere çıkarılabilmektedir.
- Akıllı ev sistemleri ile uyumlu çalışmaktadır.
- Giyotin sistemlerimiz; ses, rüzgâr ve yalıtım testleri bağımsız kuruluşlarca yapılmış olup, Avrupa standartlarında sertifikalara sahiptir. Isıcamlı sistem, 8mm standart cama göre enerji tasarrufu, rüzgâr dayanımı ve su sızdırmazlık özelliği daha yüksektir.
- Vasistaslı cam opsiyonu, yüksek katlarda cam panellerin dışarıdan temizleme imkanı sunar. Ayrıca sistem kapalıyken vasistaslı kanat açılabilir ve ortam havalandırılabilir.

## GÜVENLİK

- Sistem kapatılırken cam paneller arasında parmak sıkışması önlenmiştir. Sistem açılırken ise motor alt limiti, hareketli camla sabit cam arasında 1-2 cm boşluk olacak şekilde ayarlanarak park pozisyonunda bile sıkışma tehlikesi engellenmiş olur.
- Çelik zincirli giyotin (opsiyonel) sistem diğer uygulama tiplerine göre daha fazla güvenlik sağlar.
- Teras uygulamalarında giyotin sistemi, pencere özelliğinin yanı sıra toplanma sırasında %100 emniyetli cam korkuluk görevi de yapar.
- Özel güvenli cam ve profil sistemi ile kiltsiz güvenlik sağlar.

# GUILLOTINE GLASS SYSTEMS



With its advanced technology and functional features, Guillotine Glass Systems makes living spaces such as hotels, cafes, restaurants, residences, terraces, winter/summer gardens and shopping centers more comfortable and indispensable. As FBM, we offer four-season living spaces where you can enjoy spring, autumn or winter more spacious, wider, brighter, and therefore more enjoyable without cold, rain water or snow.

## DESIGN AND FUNCTIONALITY

- Guillotine Glass Systems provide panoramic viewing angles and natural lighting with the penetration of daylight, by moving the 8mm tempered (break-resistant) or insulating glass panels up/down with the help of a motor.

- The guillotine system engine using RTS technology works with the remote control and the motion can be stopped at the specified point thanks to the start-stop technology.

- The entire system or a single module can be operated with a remote control.

- Glass profiles, which minimally affect the aesthetics and field of view, do not obstruct the users' field of view and provide a perfect integrity with the outdoor environment with unlimited color, wood coating and pattern options.

- Rain and wind sensors that can be added to the system detect situations such as precipitation and storms when the system is on and turn off automatically.

- Guillotine systems provide 60% sound insulation. With synergy and comfort glasses that can be used in double-glazed systems, the thermal insulation feature can be increased to even higher levels.

- It works in harmony with smart home systems.

- Our guillotine systems; sound insulation, wind resistance and waterproofing tests have been carried out by independent institutions and have certificates in European standards. The insulating glass system has higher energy savings, wind resistance and water tightness than 8mm standard glass.

- The transom glass option provides the opportunity to clean the glass panels from the outside on high floors. In addition, when the system is off, the tilt wing can be opened and the environment can be ventilated.

## SECURITY

- Fingers are prevented from being caught between the glass panels while the system is being shut down. By adjusting it so that there is a gap of 1-2 cm between the moving glass and the fixed glass, the danger of finger jamming is prevented even in the parking position.

- Steel chain guillotine (optional) system provides more security than other models.

- In terraces, the guillotine system acts as a 100% safe glass railing during assembly as well as the window feature.

- It provides unlocked security with its special security glass and profile system.

## GIYOTIN CAM SİSTEMİ

1	8 mm TEK CAM	STANDART	KAYIŞLI
2	ISICAM	STANDART ALT KASALI	KAYIŞLI
3	ISICAM	STANDART ALT KASALI	ZİNCİRLİ
4	8 mm TEK CAM	ÇİFT VASİSTASLI	KAYIŞLI
5	8 mm TEK CAM	ÇİFT VASİSTASLI	ZİNCİRLİ
6	ISICAM	ÇİFT VASİSTASLI	KAYIŞLI
7	ISICAM	ÇİFT VASİSTASLI	ZİNCİRLİ



# Tek Cam (8mm) Standart Giyotin

## Single Glass Standard Guillotine

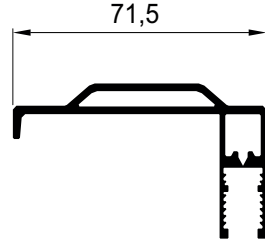
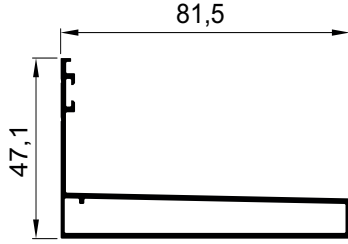
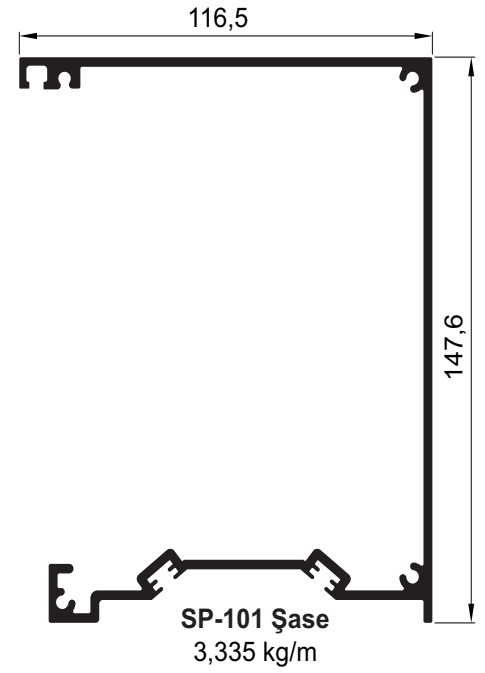
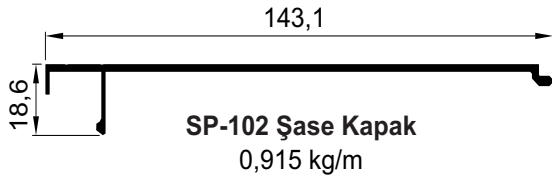

G-125 Tekcam Alt Kasa  
0,930 kg/m

G-118 Tekcam Küpeşte  
1,074 kg/m

SP-101 Şase  
3,335 kg/m

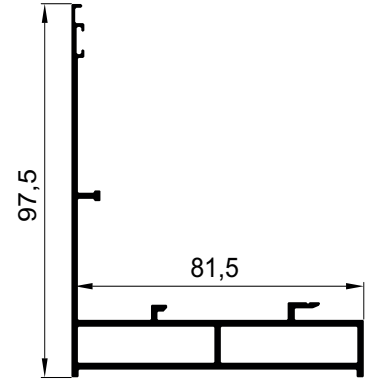
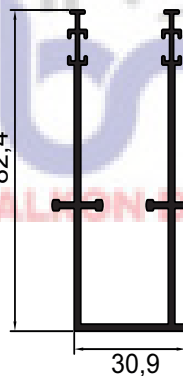
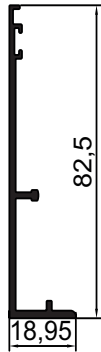

G-124 Tekcam Yan Kasa  
Dış Kapak  
0,590 kg/m

G-123 Tekcam  
Yan Kasa U  
1,290 kg/m

G-123 Tekcam  
Yan Kasa  
1,355 kg/m

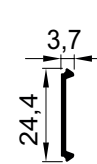
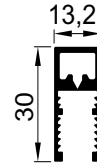
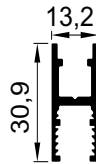
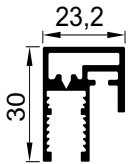

G-119 Tekcam  
Çekme Baza  
0,569 kg/m

G-121 Tekcam  
Dikey Baza  
0,395 kg/m

G-120 Tekcam  
Alt Baza  
0,400 kg/m

G-126 Tekcam Yan Kasa  
Alın Kapak  
0,169 kg/m

**UYARI!** Alüminyum profillerin, yukarıda belirtilen birim ağırlıkları yaklaşık olarak hesaplanmıştır. Gerçek birim ağırlıkları, teslimat sırasında yapılan tartım işlemi sonucuna göre hesaplanacaktır.  
**WARNING!** Above mentioned aluminium profiles unit weights have been theoretically calculated. The actual unit weight will be calculated on delivery to put into the invoicing process.

# Tek Cam (8mm) Standart Giyotin Montaj Şeması

## Single Glass Standard Guillotine Assembly Scheme

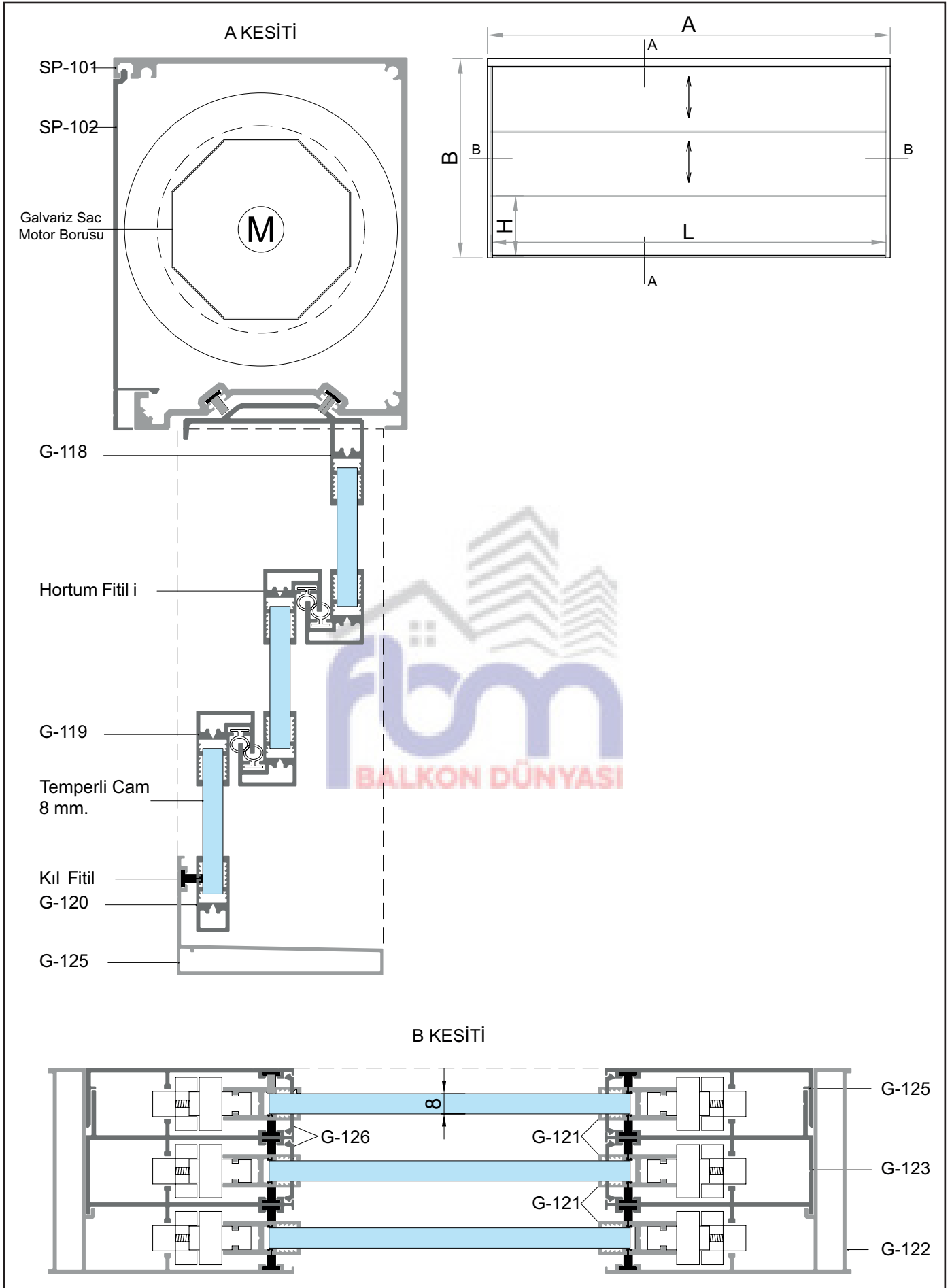

**UYARI!** Alüminyum profillerin, yukarıda belirtilen birim ağırlıkları yaklaşık olarak hesaplanmıştır. Gerçek birim ağırlıkları, teslimat sırasında yapılan tartım işlemi sonucuna göre hesaplanacaktır.  
**WARNING!** Above mentioned aluminium profiles unit weights have been theoretically calculated. The actual unit weight will be calculated on delivery to put into the invoicing process.

# Tek Cam (8mm) Standart Giyotin Aksesuar Seti

## Accessories

(GA-SET-01) Aksesuar/Ürün	Açıklama	Birim	Miktar	Kod	
	Kayış Tamburu	Tek Tip Plastik	Adet	2	GA-12
	Kayış Bağlantı Aparatı	Alüminyum	Adet	2	GA-13
	Boru Başı	Tek Tip Alüminyum	Adet	1	GA-04
	Şase Kapak	Sağ ve Sol Plastik	Adet	2	GA-05
	Şase Kapak Rulman Yatak	Rulmanlı Plastik	Adet	1	GA-06
	Küpeşte Kapak	Sağ ve Sol Plastik	Adet	2	GA-16
	İnce Seri Çekme Baza Kapak	Sağ ve Sol Plastik	Adet	10	GA-17
	Teker Kızak	Tek Tip Plastik	Adet	8	GA-10
	Alt Köşe Takoz	Sağ ve Sol plastik	Adet	2	GA-21

# Giyotin Plus Montaj Şeması

## Guillotine Assembly Scheme

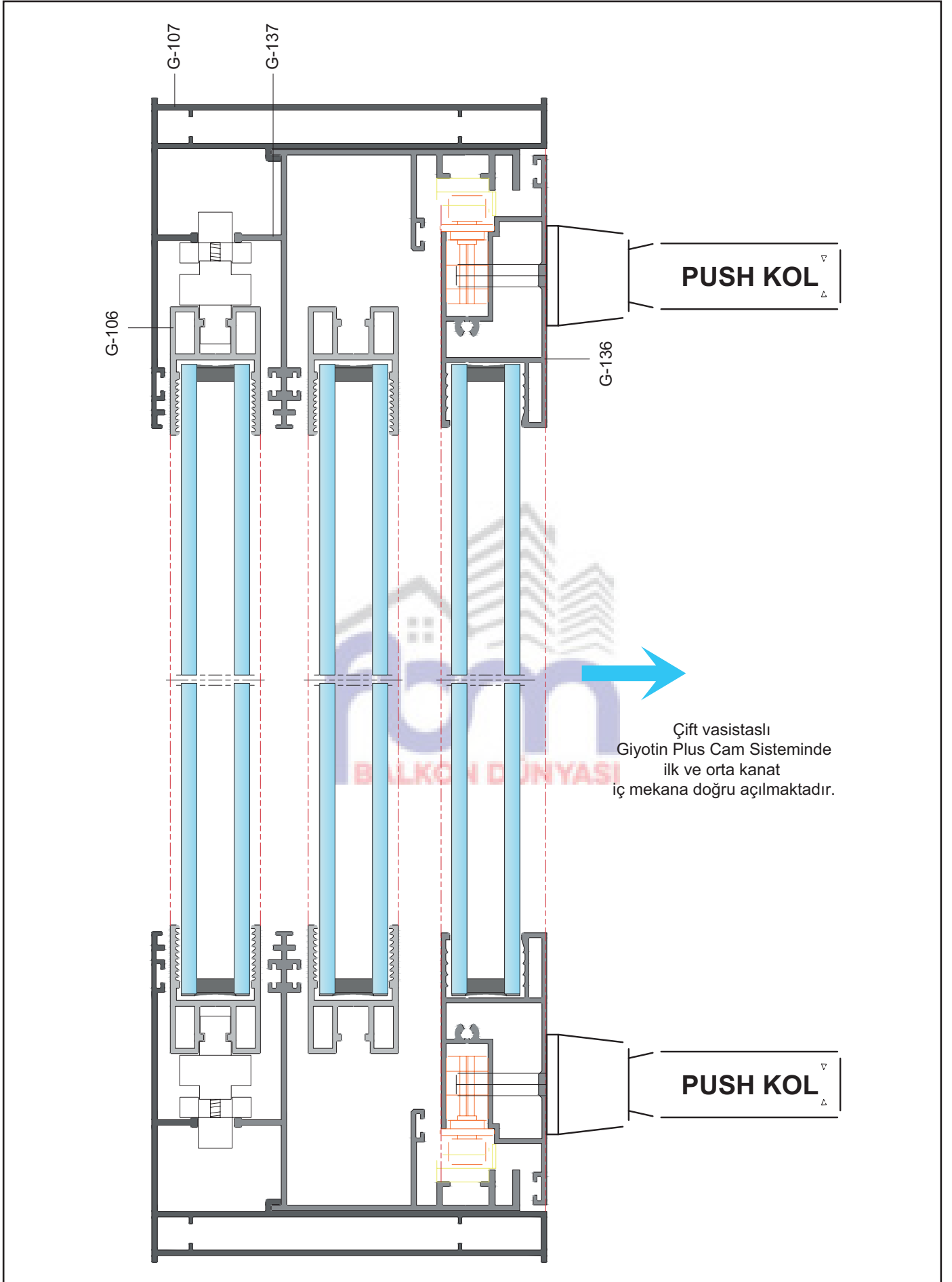

**UYARI!** Alüminyum profillerin, yukarıda belirtilen birim ağırlıkları yaklaşık olarak hesaplanmıştır. Gerçek birim ağırlıkları, teslimat sırasında yapılan tartım işlemi sonucuna göre hesaplanacaktır.  
**WARNING!** Above mentioned aluminium profiles unit weights have been theoretically calculated. The actual unit weight will be calculated on delivery to put into the invoicing process.

# Giyotin Plus Montaj Şeması

## Guillotine Assembly Scheme

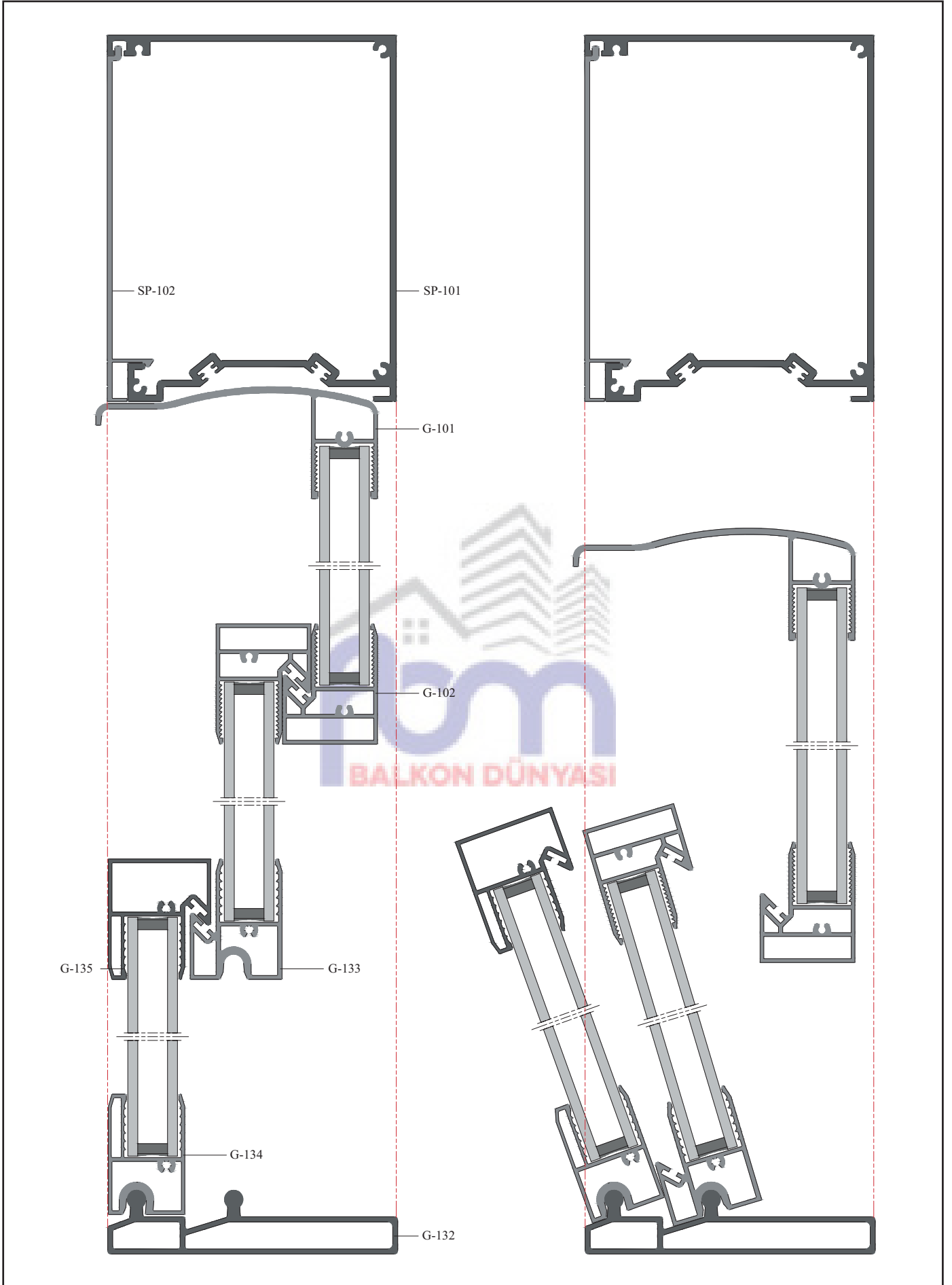

**UYARI!** Alüminyum profillerin, yukarıda belirtilen birim ağırlıkları yaklaşık olarak hesaplanmıştır. Gerçek birim ağırlıkları, teslimat sırasında yapılan tartım işlemi sonucuna göre hesaplanacaktır.  
**WARNING!** Above mentioned aluminium profiles unit weights have been theoretically calculated. The actual unit weight will be calculated on delivery to put into the invoicing process.

# Giyotin Plus Montaj Şeması

## Guillotine Assembly Scheme

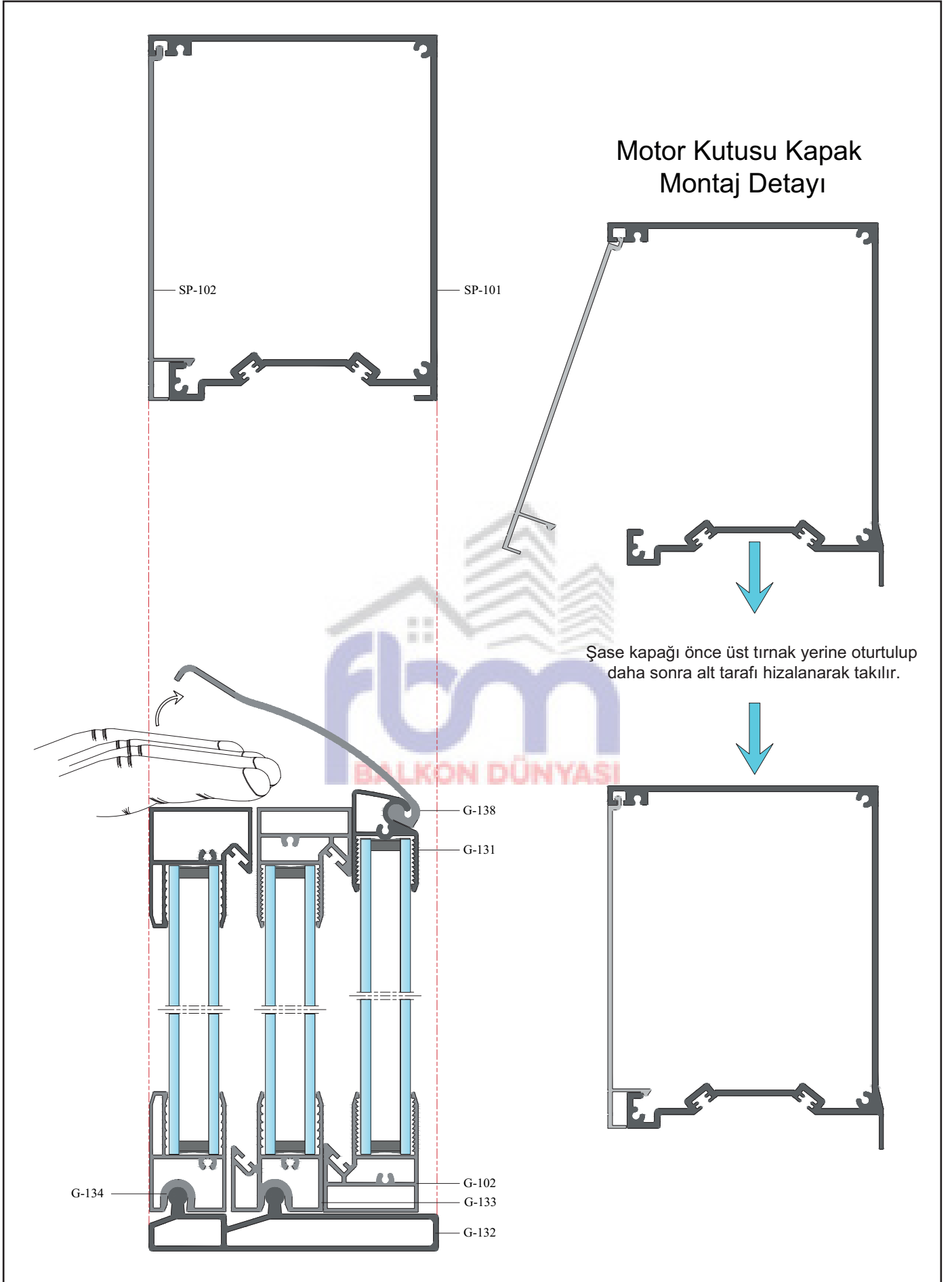

**UYARI!** Alüminyum profillerin, yukarıda belirtilen birim ağırlıkları yaklaşık olarak hesaplanmıştır. Gerçek birim ağırlıkları, teslimat sırasında yapılan tartım işlemi sonucuna göre hesaplanacaktır.  
**WARNING!** Above mentioned aluminium profiles unit weights have been theoretically calculated. The actual unit weight will be calculated on delivery to put into the invoicing process.

# ISICAM /TEKCAM Çift Vasistaslı Giyotin Plus

## Double Glazed Cleanable Guillotine Plus

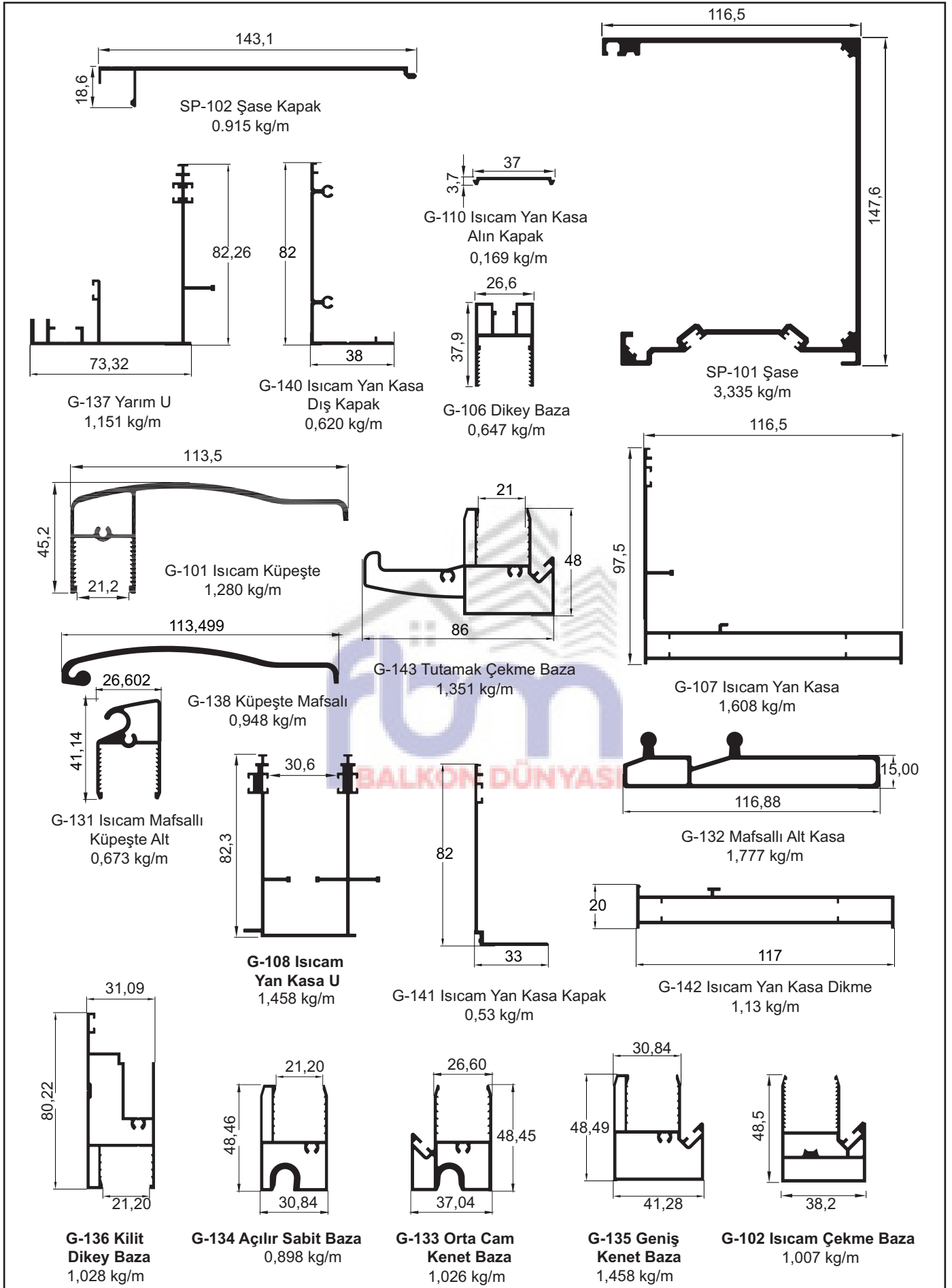

**UYARI!** Alüminyum profillerin, yukarıda belirtilen birim ağırlıkları yaklaşık olarak hesaplanmıştır. Gerçek birim ağırlıkları, teslimat sırasında yapılan tartım işlemi sonucuna göre hesaplanacaktır.  
**WARNING!** Above mentioned aluminium profiles unit weights have been theoretically calculated. The actual unit weight will be calculated on delivery to put into the invoicing process.

# ISICAM Çift Vasistaslı **Giyotin Plus**

## **Kayışlı** Aksesuar Seti

### Accessories

(GA-SET-10) Aksesuar/Ürün	Açıklama	Birim	Miktar	Kod	
	Kayış Aksesuarı	Sağ ve Sol Plastik	Adet	2	GA-11
	Kayış Tamburu	Tek Tip Plastik	Adet	2	GA-12
	Kayış Bağlantı Aparatı	Tek Tip Alüminyum	Adet	2	GA-13
	Boru Başı	Tek Tip Alüminyum	Adet	1	GA-04
	Şase Kapak	Sağ ve Sol plastik	Adet	2	GA-05
	Şase Kapak Rulman Yatak	Rulmanlı Plastik	Adet	1	GA-06
	Hareketli Küpeşte Kapak ve Dikme Kapak	Sağ ve Sol Plastik	Adet	2	GA-18 GA-19
<b>Sabit Küpeşteli sistemlerde GA-07, Hareketli Küpeşteli sistemlerde GA-18 ve GA-19 aksesuar kutularından çıkmaktadır.</b>					
	Küpeşte Kapak	Sağ ve Sol Plastik	Adet	2	GA-07
	Sabit Küpeşte Vidalama	Sağ ve Sol Plastik	Adet	2	GA-08
	Çekme Baza Kapak	Sağ ve Sol Plastik	Adet	4	GA-09
	Menteşeli Çekme Baza Kapak	Sağ ve Sol Plastik	Adet	2	GA-20
	Alt Köşe Takoz	Sağ ve Sol plastik	Adet	2	GA-21
	Teker Kızağı	Plastik	Adet	4	GA-10

**ISICAM Çift Vasistaslı Giyotin Plus**  
**Kayıklı Aksesuar Seti**  
Accessories

(GA-SET-15) Aksesuar/Ürün	Açıklama	Birim	Miktar	Kod	
	Kilit Yan Kasa Kapak	Sağ ve Sol Plastik	Adet	2	GA-22
	Kilit Baza Kapak	Sağ ve Sol Plastik	Adet	2	GA-23
	Menteşeli Sabit Baza Kapak	Sağ ve Sol Plastik	Adet	2	GA-24
	Giyotin Plus Makası	Sağ ve Sol	Adet	2	GA-25
	Giyotin Plus Makas Plastiği	Plastik	Adet	2	GA-42
	Switch	Elektronik	Adet	1	GA-43
	Tutamaklı Çekme Kapağı	Sağ ve Sol Plastik	Adet	2	GA-44
	Orta Cam Sabitleme	Plastik	Adet	2	GA-45
	Alt Baza Sabitleme	Plastik	Adet	2	GA-46
	İspanyolet Tiji	20 CM	Adet	2	GA-28
	Push Kilit Kol / Çekme Kilit	Bas Çek Kol / Çekme	Opsiyonel Kilit	2	GA-27

# ISICAM Çift Vasistaslı **Giyotin Plus**

## Zincirli Aksesuar Seti

### Accessories

(GA-SET-11) Aksesuar/Ürün	Açıklama	Birim	Miktar	Kod	
	Zincirli Gergi Kapak	Sağ ve Sol Plastik	Adet	2	GA-01
	Dişli	Tek Tip Çelik	Adet	2	GA-02
	Zincir Bağlantı Aparatı	Alüminyum	Adet	2	GA-03
	Boru Başı	Tek Tip Alüminyum	Adet	1	GA-04
	Şase Kapak	Sağ ve Sol plastik	Adet	2	GA-05
	Şase Kapak Rulman Yatak	Rulmanlı Plastik	Adet	1	GA-06
	Hareketli Küpeşte Kapak ve Dikme Kapak	Sağ ve Sol Plastik	Adet	2	GA-18 GA-19
<b>Sabit Küpeşteli sistemlerde GA-07, Hareketli Küpeşteli sistemlerde GA-18 ve GA-19 aksesuar kutularından çıkmaktadır.</b>					
	Küpeşte Kapak	Sağ ve Sol Plastik	Adet	2	GA-07
	Sabit Küpeşte Vidalama	Sağ ve Sol Plastik	Adet	2	GA-08
	Çekme Baza Kapak	Sağ ve Sol Plastik	Adet	4	GA-09
	Menteşeli Çekme Baza Kapak	Sağ ve Sol Plastik	Adet	2	GA-20
	Alt Köşe Takoz	Sağ ve Sol plastik	Adet	2	GA-21
	Teker Kızağı	Plastik	Adet	4	GA-10

# ISICAM Çift Vasistaslı **Giyotin Plus**

## Zincirli Aksesuar Seti

### Accessories

(GA-SET-15) Aksesuar/Ürün	Açıklama	Birim	Miktar	Kod	
	Kilit Yan Kasa Kapak	Sağ ve Sol Plastik	Adet	2	GA-22
	Kilit Baza Kapak	Sağ ve Sol Plastik	Adet	2	GA-23
	Menteşeli Sabit Baza Kapak	Sağ ve Sol Plastik	Adet	2	GA-24
	Giyotin Plus Makası	Sağ ve Sol	Adet	2	GA-25
	Giyotin Plus Makas Plastik	Plastik	Adet	2	GA-42
	Switch	Elektronik	Adet	1	GA-43
	Tutamaklı Çekme Kapağı	Sağ ve Sol Plastik	Adet	2	GA-44
	Orta Cam Sabitleme	Plastik	Adet	2	GA-45
	Alt Baza Sabitleme	Plastik	Adet	2	GA-46
	İspanyolet Tiji	20 CM	Adet	2	GA-28
	Push Kilit Kol / Çekme Kilit	Bas Çek Kol / Çekme	Opsiyonel Kilit	2	GA-27

# PERGOLA



Meşe ağacından esinlenerek özel olarak tasarlanmış olan Pergola Sistemleri; gelişmiş teknolojisi ve fonksiyonel özellikleri ile otel, cafe, restaurant, konut, teras, kış/yaz bahçesi, alışveriş merkezleri gibi yaşam alanlarını daha konforlu ve vazgeçilmez hale getirir. Giyotin, zip perde ve sürme cam sistemleri ile birlikte montajı yapılarak doğanın olumsuz yönlerini değil, sadece güzelliklerini yaşatır.

## TASARIM VE FONKSİYONELLİK

- Pergola Sistemleri; alüminyum taşıyıcılar üzerine adapte edilmiş, özel tasarım kumaşlarla tasarlanmış açılır & kapanır bir sistemdir.
- RTS teknolojisi kullanan pergola sistem motoru, uzaktan kumanda ile çalışır ve start-stop teknolojisi sayesinde hareket istenildiği noktada durdurulabilir.
- Sistemin tamamı veya tek bir modülü uzaktan kumanda ile çalıştırılabilir.
- Sisteme eklenebilen yağmur ve rüzgâr sensörleri, sistem açık durumdayken yağış ve fırtına gibi durumları algılar ve otomatik kapanır.
- Led ve şerit aydınlatma sayesinde 7/24 kullanım alanı oluşturur.
- Drenaj sisteminin hem kirişler hem de sütunlar içerisine entegre olan gizli kısmı, yağmur ve kar suyunun tahliye edilmesini mümkün kılmaktadır.



FBM ALÜMİNYUM Pergola Systems, specially designed with inspiration from oak wood; with its advanced technology and functional features, it makes living spaces such as hotels, cafes, restaurants, residences, terraces, winter/summer gardens, shopping centers more comfortable and indispensable. Experience only the beauties of nature, not the negative aspects, by installing it together with guillotine, zip curtain and sliding glass systems.

## DESIGN AND FUNCTIONALITY

- FBM ALÜMİNYUM Pergola Systems is an opening & closing system designed with specially designed fabrics, adapted on aluminum carriers.
- The pergola system engine using RTS technology works with a remote control and the movement can be stopped at any point thanks to the start-stop technology.
- The entire system or a single module can be operated with a remote control.
- With rain and wind sensors that can be added to the system, the system detects rain and storm conditions when it is on and turns off automatically.
- It creates a 24/7 usage area with LED lighting.
- The hidden part of the drainage system, which is integrated into both beams and columns, makes it possible to evacuate rain and water.

# Düz/Oval Pergola

## Flat / Oval Pergola

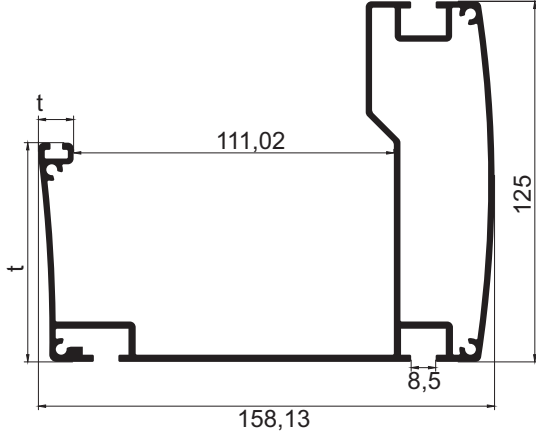

**P-106 Orta Seri Oluk**  
3,916 kg/m

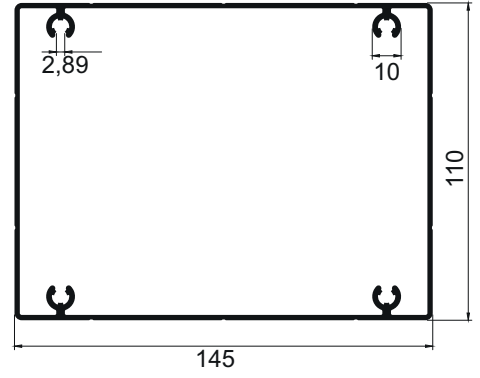

**P-107 Ayak 100x145**  
3,440 kg/m

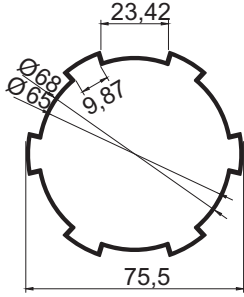

**P-105 75'lik Boru**  
1,100 kg/m

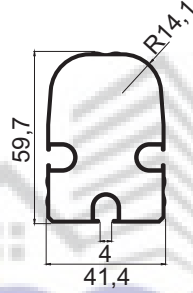

**P-104 İnce Korniş**  
0,937 kg/m

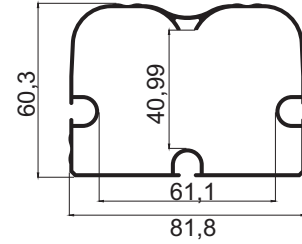

**P-103 Kalın Korniş**  
1,280 kg/m

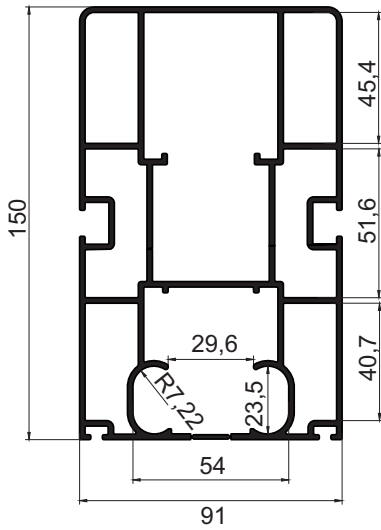

**P-102 Orta Seri Ray**  
5,217 kg/m

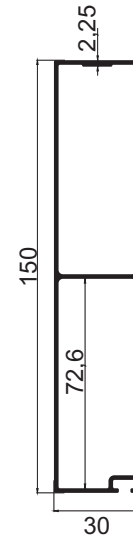

**P-101 30x150 Kutu**  
1,711 kg/m

**flm**  
BALKON DÜNYASI

**UYARI!** Alüminyum profillerin, yukarıda belirtilen birim ağırlıkları yaklaşık olarak hesaplanmıştır. Gerçek birim ağırlıkları, teslimat sırasında yapılan tartım işlemi sonucuna göre hesaplanacaktır.  
**WARNING!** Above mentioned aluminium profiles unit weights have been theoretically calculated. The actual unit weight will be calculated on delivery to put into the invoicing process.



FBM ALÜMİNYUM Bioklimatik Sistemleri; gelişmiş teknolojisi ve katlanma-toplanma özelliğini ile otel, kafe, restaurant, konut, teras, kış/yaz bahçesi, alışveriş merkezleri gibi yaşam alanlarını daha konforlu ve vazgeçilmez hale getirir. Giyotin, zip perde ve sürme cam sistemleri ile birlikte montaj imkanı vardır.

## TASARIM VE FONKSİYONELLİK

- Bioklimatik sistemde; tavan kapanma malzemeleri olarak kullanılan paneller, kendi ekseninde dönerek katlanma hareketini gerçekleştirir. Katlanma hareketini tamamladıktan sonra alüminyum paneller geriye doğru toplanarak tam bir açık tavan alanı elde edilir. Panellerin yaptığı katlanma hareketi sayesinde, çatıdan havalandırma yaparken gölgelendirme özelliğini kaybetmez.

- Açılır tavan sistemi su tahliye mantığı ile çalışmaktadır. Alüminyum paneller üzerine gelen kar/yağmur suyu, paneller üzerinde bulunan ark sayesinde ana ark profiline aktarılmakta ve ana ark profilinden dış alana tahliyesi sağlanmaktadır.

- Yağışlı havalarda, paneller belli bir açıda ayarlanarak, yaşam alanının havalandırması sağlanırken su girişini engelleyecek şekilde tasarlanmıştır.

- Opsiyonel olarak panel içlerine poliüreten köpük uygulanarak, yalıtım özelliği daha üst seviyelere çıkarılabilir.

- RTS teknolojisi kullanan giyotin sistem motoru uzaktan kumanda ile çalışır ve start-stop teknolojisi sayesinde hareket istenildiği noktada durdurulabilir. Sistemin tamamı veya tek bir modülü uzaktan kumanda ile çalıştırılabilir.

- Sisteme eklenebilen yağmur ve rüzgâr sensörleri, sistem açık durumdayken yağış ve fırtına gibi durumları algılar ve otomatik kapanır.



FBM ALÜMİNYUM Bioclimatic Systems makes living spaces such as hotels, cafes, restaurants, residences, terraces, winter/summer gardens, shopping centers more comfortable and indispensable with its advanced technology and folding-collecting feature. It is possible to assemble with guillotine, zip curtain and sliding glass systems.

## DESIGN AND FUNCTIONALITY

- The panels, which are used as ceiling closing materials in the bioclimatic system, rotate around their own axis and perform the folding movement. After completing the folding motion, the aluminum panels are folded back to create a full open ceiling area. With the folding movement of the panels, it does not lose its shading feature while ventilating from the roof.
- Snow/rain water collected on aluminum panels is transferred to the main arc profile with the arc on the panels. Rain water is discharged from the main arc profile to the outside.
- In rainy weather, the panels are adjusted at a certain angle and designed to prevent water ingress while providing ventilation of the living space.
- The insulation feature can be increased to higher levels by filling the panel with polyurethane foam (optional).
- The bioklimatic system engine using RTS technology works with a remote control and the motion can be stopped at any point thanks to the start-stop technology. The entire system or a single module can be operated with a remote control.
- Rain and wind sensors that can be added to the system detect situations such as precipitation and storms when the system is on and turn off automatically.

# Bioklimatik Bioclimatic

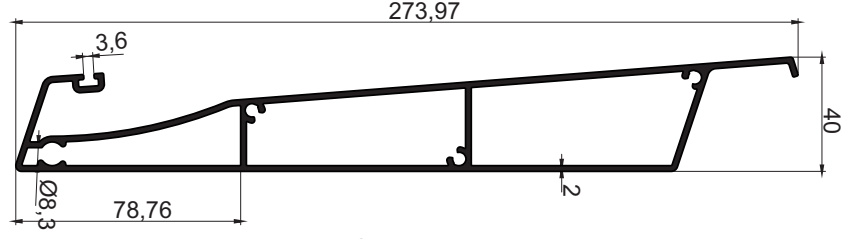

**BC-101 Lamel**  
3,705 kg/m

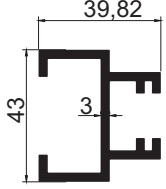

**BC-105 K-Ray**  
1,171 kg/m

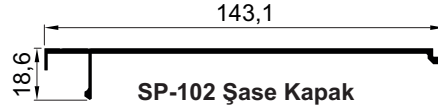

**SP-102 Şase Kapak**  
0,915 kg/m

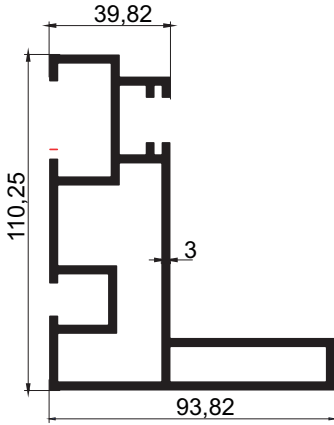

**BC-106 B-Ray**  
3,984 kg/m

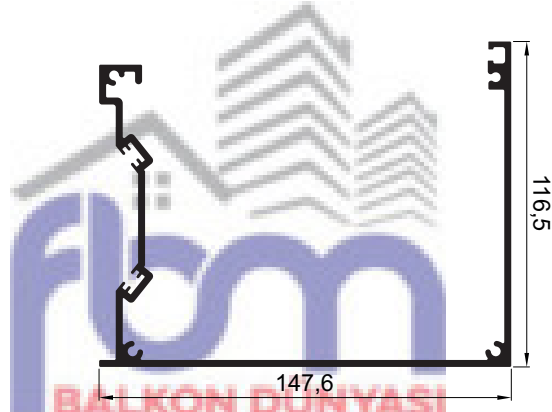

**SP-101 Şase**  
3,335 kg/m

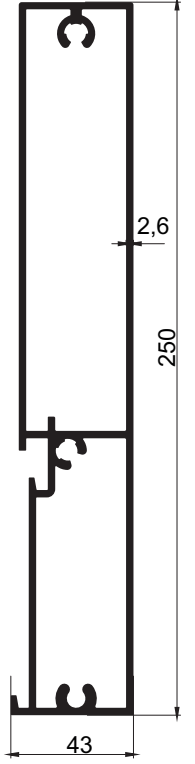

**BC-102 Kapatma**  
4,494 kg/m

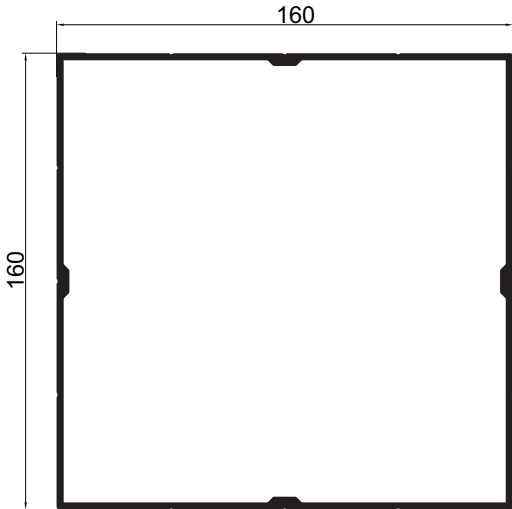

**BC-107 160x160 Ayak**  
4,472 kg/m

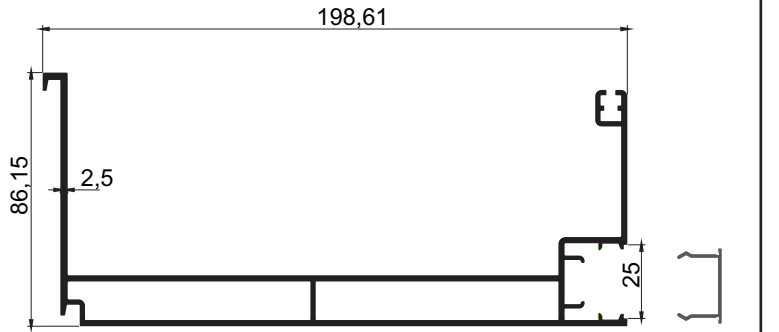

**BC-103 Oluk**  
3,512 kg/m

**BC-109  
Led Kapak**

**UYARI!** Alüminyum profillerin, yukarıda belirtilen birim ağırlıkları yaklaşık olarak hesaplanmıştır. Gerçek birim ağırlıkları, teslimat sırasında yapılan tartım işlemi sonucuna göre hesaplanacaktır.  
**WARNING!** Above mentioned aluminium profiles unit weights have been theoretically calculated. The actual unit weight will be calculated on delivery to put into the invoicing process.

# CAM TAVAN SİSTEMLERİ / GLASSING CEILING SYSTEMS

Cam Tavan Sistemleri; otel, kafe, restoran, villa, konut, teras, kış/yaz bahçesi, alışveriş merkezleri ve havuz gibi mekanlarda gün ışığından dört mevsim yararlanmak ve gökyüzü ile aranızdaki engeli ortadan kaldırmak için geliştirilmiştir. Cam tavan ile kışın yağmur, kar ve soğuk havayı dışarıda bırakabilir, yaz aylarında ise güneşin tadını doyasıya çıkartabilirsiniz. Ayrıca giyotin, zip perde ve sürme cam sistemleri ile birlikte montaj imkanı vardır.

## TASARIM VE FONKSİYONELLİK

- Cam tavan sistemi için temperli (kırılmaya dayanıklı), ısıcam, lamine ve fiberglass cam seçenekleri bulunmaktadır.



- Led ve şerit aydınlatma sayesinde 7/24 kullanım alanı oluşturur.

- Drenaj sisteminin hem kirişler hem de sütunlar içerisine entegre olan gizli kısmı, yağmur ve kar suyunun tahliye edilmesini mümkün kılmaktadır.

Glass Ceiling Systems have been developed to take advantage of daylight in all four seasons and to remove the obstacle between you and the sky in places such as hotels, cafes, restaurants, villas, residences, terraces, winter/summer gardens,

shopping centers and pools. With the glass roof, you can leave out rain, snow and cold weather in winter and enjoy the sun in summer. In addition, it is possible to install with guillotine, zip curtain and sliding glass systems.

## DESIGN AND FUNCTIONALITY

- Tempered (break resistant), double glazing, laminated and fiberglass glass options are available for the glass ceiling system.

- It creates a 24/7 usage area with LED and strip lighting.

- The hidden part of the drainage system, which is integrated into both beams and columns, makes it possible to drain rain and snow water.

# Cam Tavan

## Glassing Celing

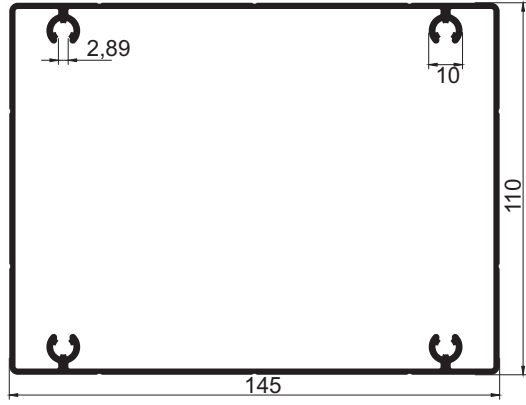

CT-107 110x145 Ayak  
3,044 kg/m

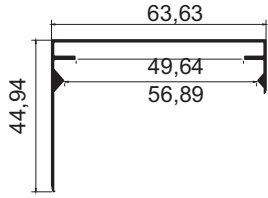

CT-209 Orta Kayıt Kenar Kapak  
0,415 kg/m



CT-206 Oluk Kapak  
0,600 kg/m

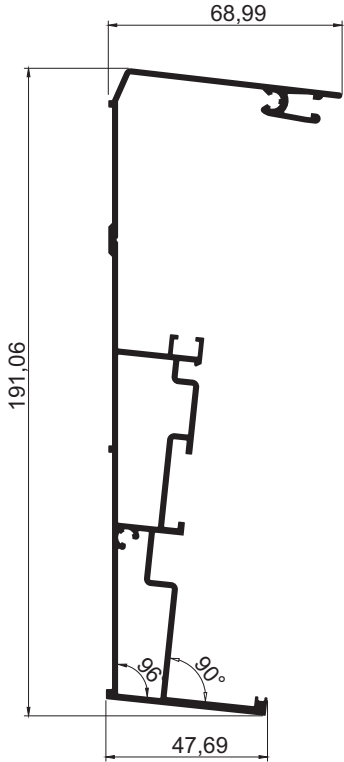

CT-205 Duvar Sabitleme  
2,651 kg/m

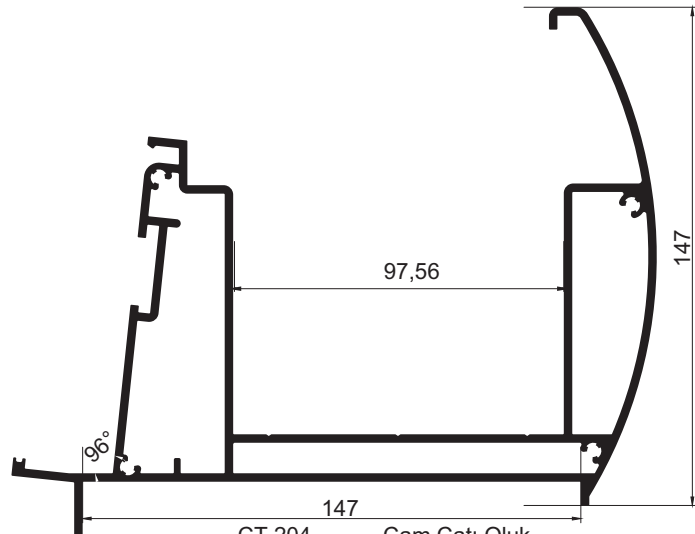

CT-204 Cam Çatı Oluk  
5,619 kg/m

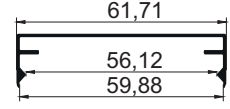

CT-207 Cam Çatı Üst Kapak  
0,312 kg/m

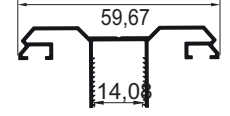

CT-203 Cam Çatı Kapak  
0,515 kg/m

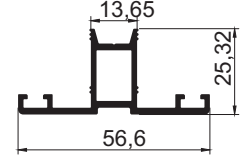

CT-202 Cam Çatı  
0,670 kg/m

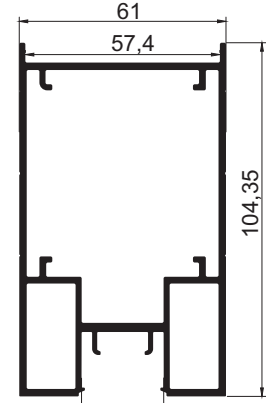

CT-201 Cam Bini  
2,630 kg/m

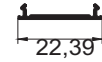

CT-208 Cam Bini  
0,110 kg/m

**UYARI!** Alüminyum profillerin, yukarıda belirtilen birim ağırlıkları yaklaşık olarak hesaplanmıştır. Gerçek birim ağırlıkları, teslimat sırasında yapılan tartım işlemi sonucuna göre hesaplanacaktır.  
**WARNING!** Above mentioned aluminium profiles unit weights have been theoretically calculated. The actual unit weight will be calculated on delivery to put into the invoicing process.

# Cam Tavan Aksesuar Seti

## Accessories

Aksesuar/Ürün	Açıklama	Adet	Birim	Kod	
	Duvar Montaj Aksesuarı	Çelik veya Plastik	Adet	2	CTA-11
Duvar montaj aksesuarı ve Oluk Kapağı müşterinin isteğine göre plastik veya metal olarak verilir.					
	Oluk Kapağı	Çelik veya Plastik	Adet	2	CTA-12
	Filtre	Tek Tip Plastik	Adet	2	CTA-03
	110*145 Ayak Döküm	Tek Tip Çelik	Adet	2	CTA-04
	110*145 Ayak Montaj Lazer Klavuzu	Tek Tip Çelik	Adet	1	CTA-15
	110*145 Ayak Montaj Lazeri	Tek Tip Çelik	Adet	2	CTA-13
	Cam Çatı Köşe Lazeri	Tek Tip Çelik	Adet	16	CTA-14



# SÜRME CAM SİSTEMLERİ / SLIDING GLASS SYSTEMS

Sürme Cam Sistemleri; otel, kafe, restoran, villa, konut, teras, kış/yaz bahçesi, alışveriş merkezleri gibi mekanlarda bölmeler oluşturmak ve büyük alanları bölmek için geliştirilmiştir. Pergola, bioklimatik ve cam tavan ile birlikte kullanımı sayesinde dört mevsim yaşam alanının oluşturabilirsiniz.

## TASARIM VE FONKSİYONELLİK

• sürme cam sistemleri, yatay doğrultuda raylar üzerinde hareket eden kanatlardan oluşmaktadır. Sistem uzunluğuna göre 3'lü veya 4'lü ray detaylarına göre üretilmektedir.

• 8mm temperli cam veya 4+12+4 ısıcam kullanılmaktadır.

• Sistemin alt rayına entegre edilmiş drenaj kanalları sayesinde, kar veya yağmur suyu kolaylıkla tahliye edilebilmektedir.

• Sistemdeki cam panellerin kolay hareket etmesi için rulmanlı ve yükseklik ayarı yapılabilen iki adet teker takımı kullanılmaktadır.

Sliding Glass Systems has been developed to create partitions and divide large areas in places such as hotels, cafes, restaurants, villas, residences, terraces, winter/summer gardens, shopping centers. You can create a four-season living space with the use of pergola, bioclimatic and glass ceiling.

## DESIGN AND FUNCTIONALITY

• sliding glass systems consist of wings that move on rails in the horizontal direction. It is produced according to the length of the system, according to the details of 3 or 4 tracks.

• 8mm tempered glass or 4+12+4 double glass is used.

• Snow or rain water can be easily discharged with

the drainage channels integrated into the bottom rail of the system.

• In order for the glass panels in the system to move easily, two wheel sets with ball bearings and height adjustment are used.



## SÜRME CAM SİSTEMİ

1	2'li Ekşikli Sürme	8 mm Tek Cam / ISICAM (4 + 12 HB + 4)
2	3'lü Ekşikli Sürme	8 mm Tek Cam / ISICAM (4 + 12 HB + 4)
3	3'lü Ekşiksiz Sürme	8 mm Tek Cam / ISICAM (4 + 12 HB + 4)
4	4'lü Ekşikli Sürme	8 mm Tek Cam / ISICAM (4 + 12 HB + 4)
5	4'lü Ekşiksiz Sürme	8 mm Tek Cam / ISICAM (4 + 12 HB + 4)
6	5'li Ekşikli Sürme	8 mm Tek Cam / ISICAM (4 + 12 HB + 4)
7	5'li Ekşikli Sürme	8 mm Tek Cam / ISICAM (4 + 12 HB + 4)



# Isıcam Eşikli 2'li Sürme Cam Sistemi

## Double Glazed Sliding Glass System

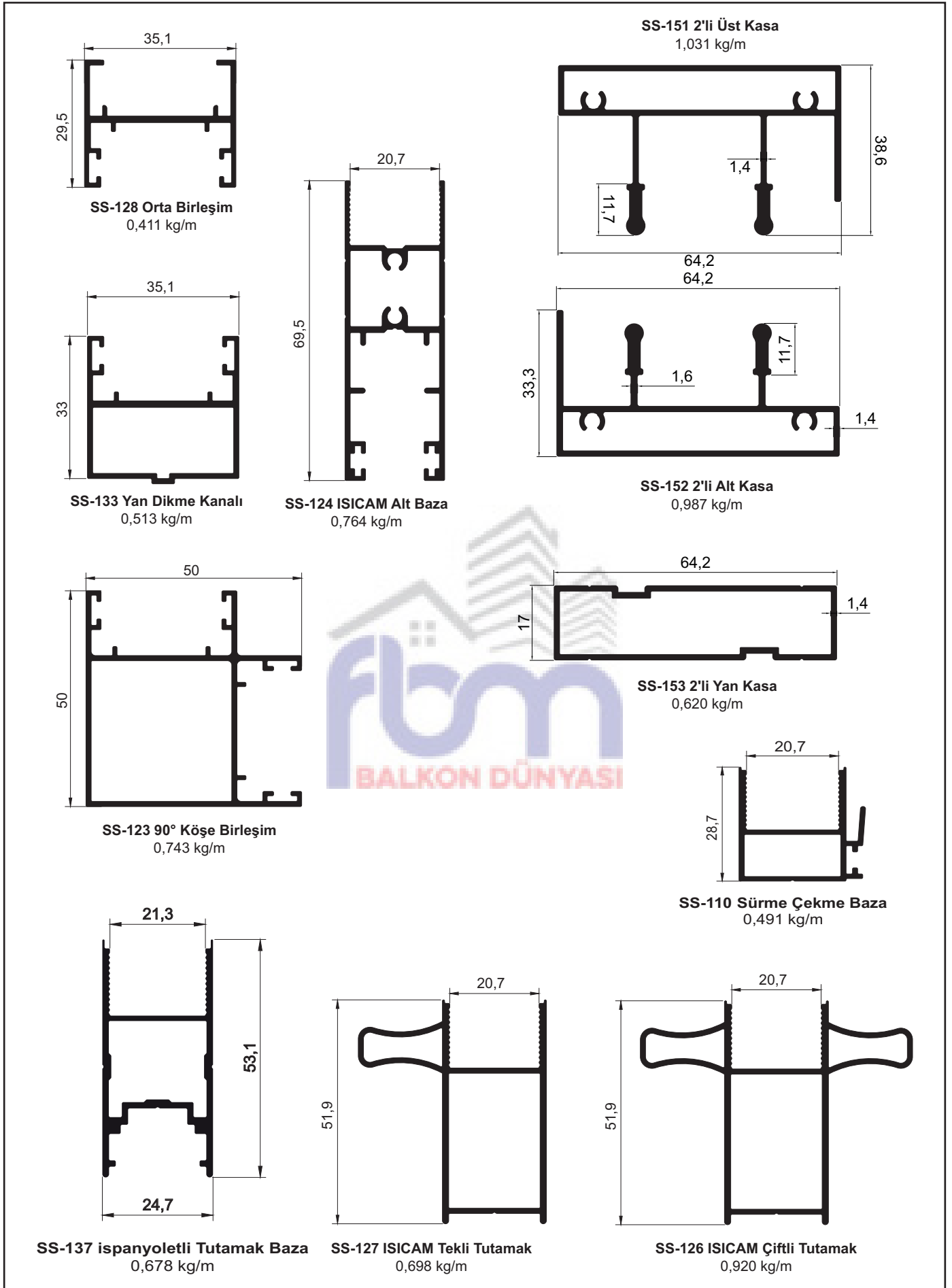

www.fbmaluminyum.com

**UYARI!** Alüminyum profillerin, yukarıda belirtilen birim ağırlıkları yaklaşık olarak hesaplanmıştır. Gerçek birim ağırlıkları, teslimat sırasında yapılan tartım işlemi sonucuna göre hesaplanacaktır.  
**WARNING!** Above mentioned aluminium profiles unit weights have been theoretically calculated. The actual unit weight will be calculated on delivery to put into the invoicing process.

# Sürme Cam Sistemleri Aksesuar

## Accessories

Eşikli 2'li Sürme (SA-SET-9) Aksesuarı	Açıklama	Adet	Birim	Kod	
	2'li Alt Köşe Takozu (Sağ ve Sol)	Tek Tip Plastik	2	Adet	SA-03
	2'li Üst Köşe Takozu (Sağ ve Sol)	Tek Tip Plastik	2	Adet	SA-04
	Üst Dikey U	Tek Tip Plastik	2	Adet	SA-10
	Alt Dikey U	Tek Tip Plastik	2	Adet	SA-11
	Tutamak Tapası (Sağ ve Sol)	Tek Tip Plastik	4	Adet	SA-05
	Cam Kapama	Tek Tip Plastik		Adet	SA-06
	Teker	Tek Tip	4	Adet	SA-07
	Üst Tozluk	Tek Tip Plastik	2	Adet	SA-08
	Alt Tozluk	Tek Tip Plastik	2	Adet	SA-09

# Isıcam Eşikli 3'lü Sürme Cam Sistemi

## Triple Double Glazed Sliding Glass System

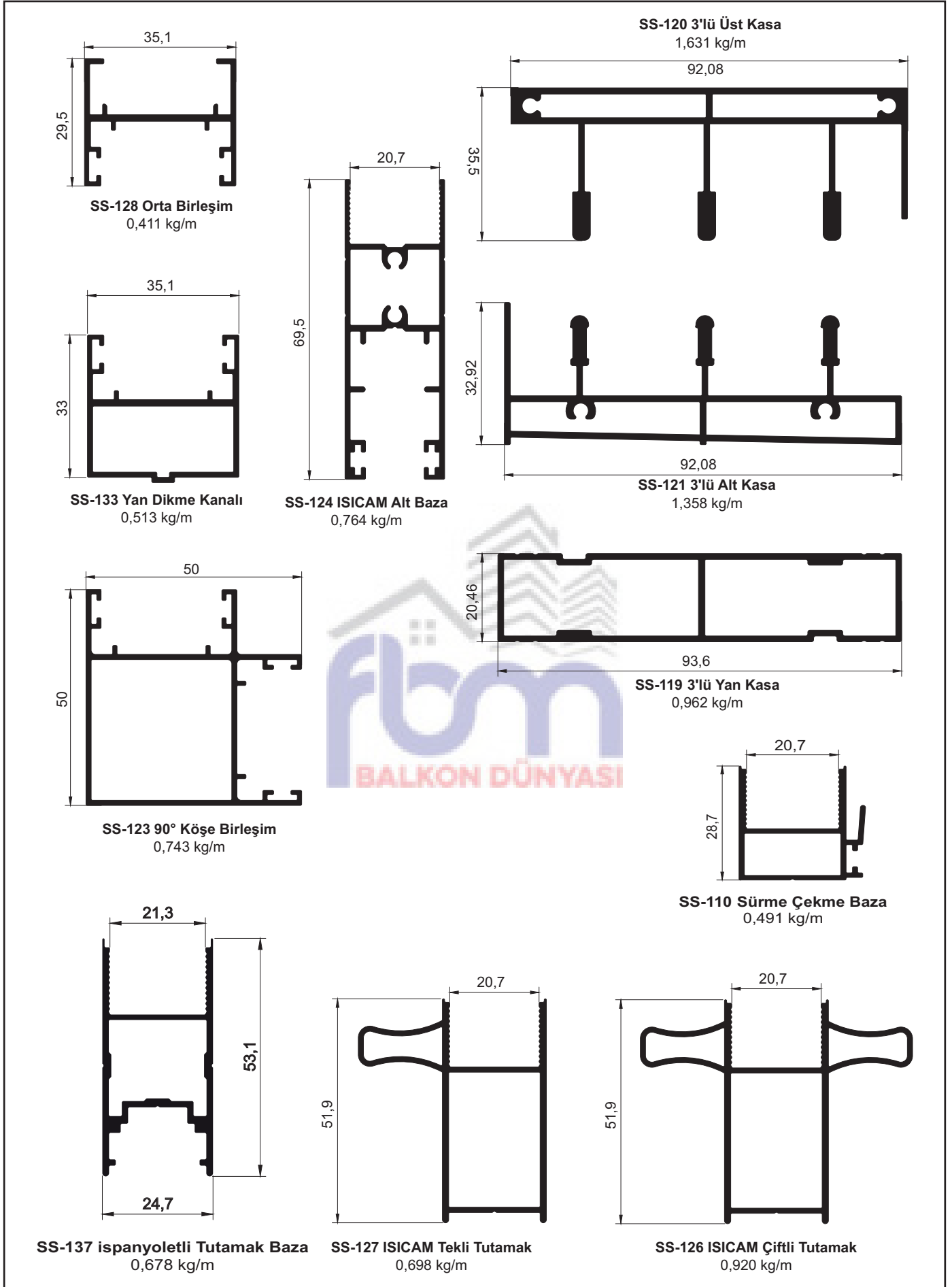

**UYARI!** Alüminyum profillerin, yukarıda belirtilen birim ağırlıkları yaklaşık olarak hesaplanmıştır. Gerçek birim ağırlıkları, teslimat sırasında yapılan tartım işlemi sonucuna göre hesaplanacaktır.  
**WARNING!** Above mentioned aluminium profiles unit weights have been theoretically calculated. The actual unit weight will be calculated on delivery to put into the invoicing process.

# Sürme Cam Sistemleri Aksesuar

## Accessories

Eşikli 3'lü Sürme (SA-SET-1) Aksesuarı	Açıklama	Adet	Birim	Kod	
	3'lü Alt Köşe Takoza (Sağ ve Sol)	Tek Tip Plastik	2	Adet	SA-03
	3'lü Üst Köşe Takoza (Sağ ve Sol)	Tek Tip Plastik	2	Adet	SA-04
	Üst Dikey U	Tek Tip Plastik	2	Adet	SA-10
	Alt Dikey U	Tek Tip Plastik	2	Adet	SA-11
	Tutamak Tapası (Sağ ve Sol)	Tek Tip Plastik	4	Adet	SA-05
	Cam Kapama	Tek Tip Plastik	12	Adet	SA-06
	Teker	Tek Tip	6	Adet	SA-07
	Üst Tozluk	Tek Tip Plastik	2	Adet	SA-08
	Alt Tozluk	Tek Tip Plastik	2	Adet	SA-09

# Sürme Cam Montaj Şeması

## Sliding Glass Assembly Scheme

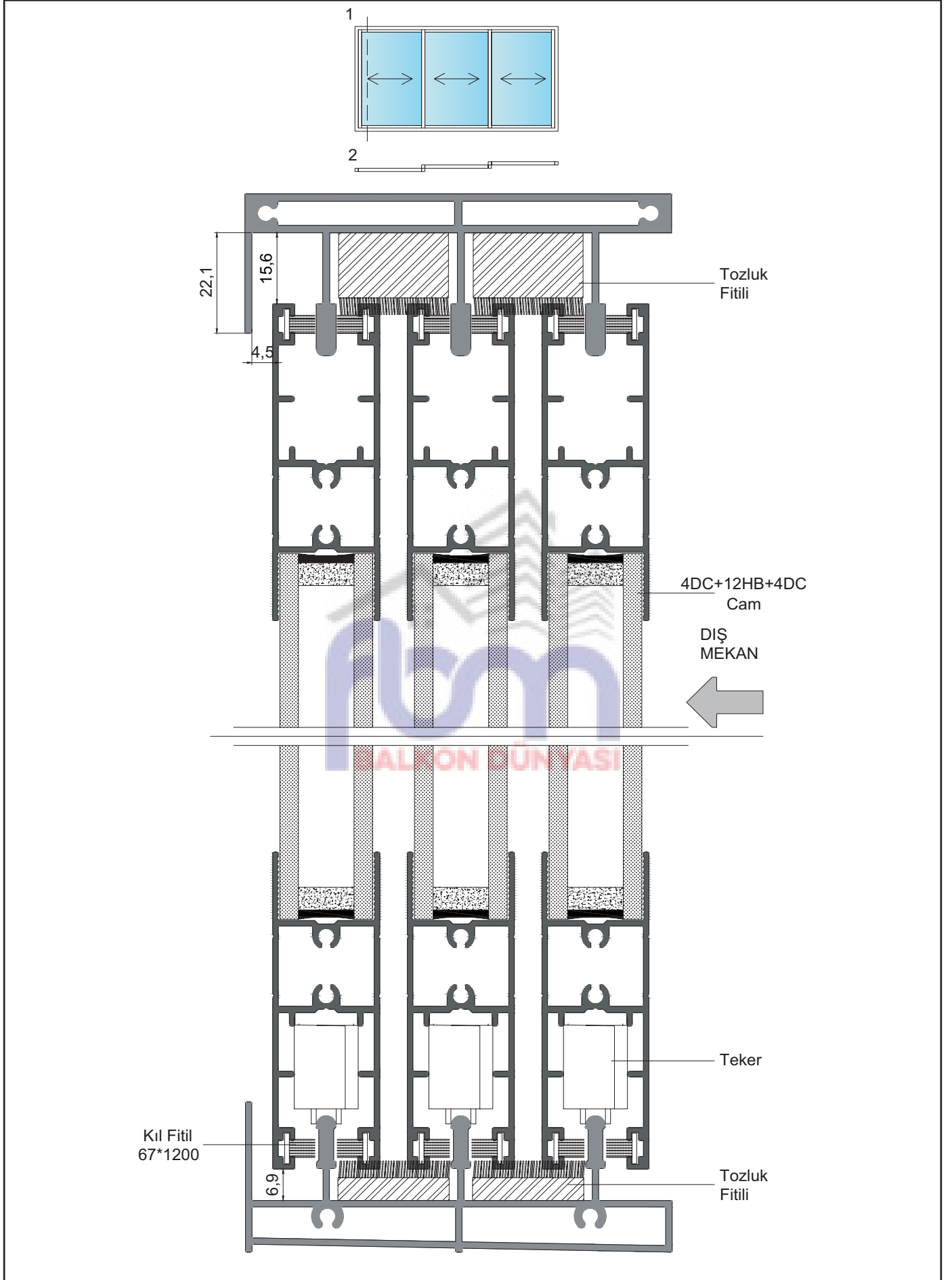

**UYARI!** Alüminyum profillerin, yukarıda belirtilen birim ağırlıkları yaklaşık olarak hesaplanmıştır. Gerçek birim ağırlıkları, teslimat sırasında yapılan tartım işlemi sonucuna göre hesaplanacaktır.  
**WARNING!** Above mentioned aluminium profiles unit weights have been theoretically calculated. The actual unit weight will be calculated on delivery to put into the invoicing process.

# Sürme Cam Montaj Şeması

## Sliding Glass Assembly Scheme

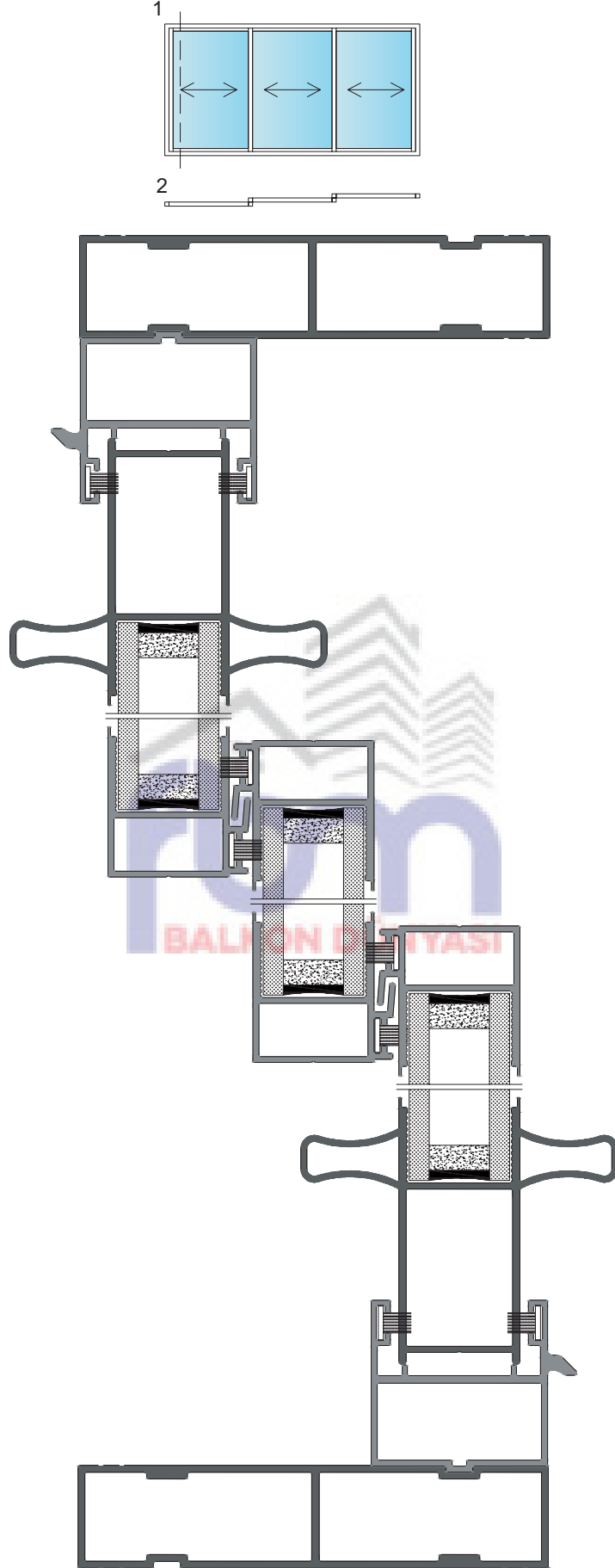

**UYARI!** Alüminyum profillerin, yukarıda belirtilen birim ağırlıkları yaklaşık olarak hesaplanmıştır. Gerçek birim ağırlıkları, teslimat sırasında yapılan tartım işlemi sonucuna göre hesaplanacaktır.  
**WARNING!** Above mentioned aluminium profiles unit weights have been theoretically calculated. The actual unit weight will be calculated on delivery to put into the invoicing process.

# Sürme Cam Montaj Şeması

## Sliding Glass Assembly Scheme

### Aksesuar Montaj Detayı

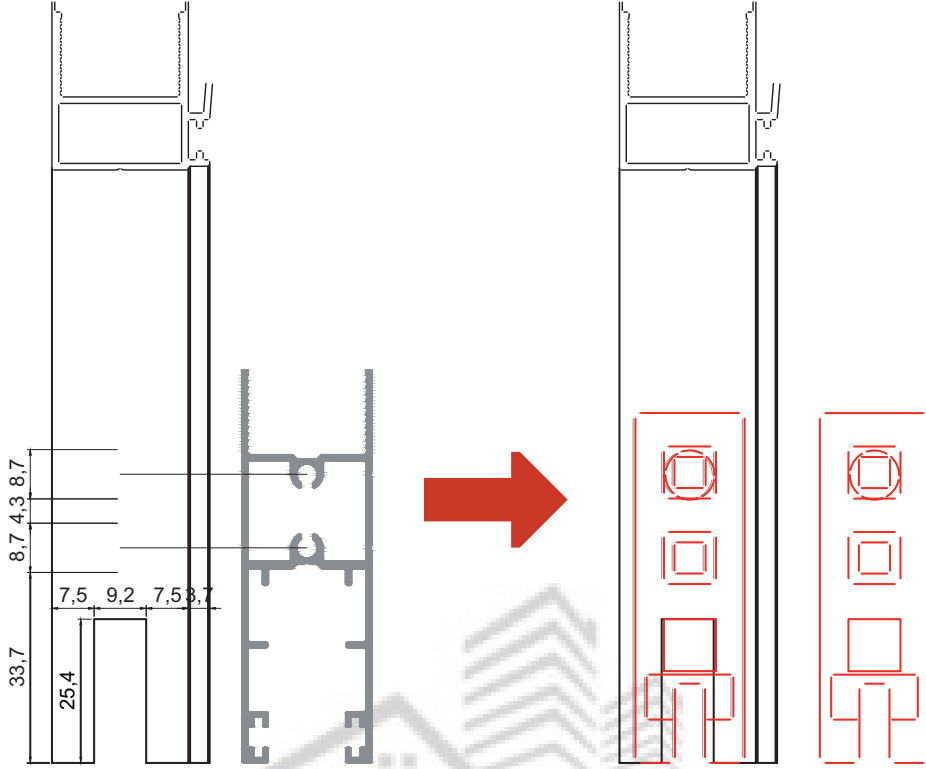

Profiller şekildeki gibi kervillecek.  
Camların yatay taşıyıcıları dik taşıyıcılar  
arasında kalacak.

Profiller kervilledikten sonra  
montaj öncesinde plastik aksesuarlar  
tokmak yardımıyla takılır.

### Aksesuar Montaj Detayı

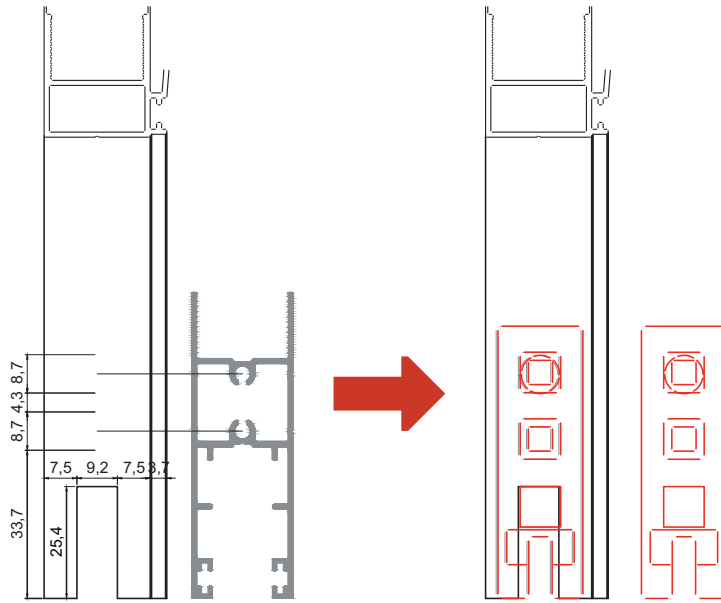

Profiller şekildeki gibi kervillecek.  
Camların yatay taşıyıcıları dik taşıyıcılar  
arasında kalacak.

Profiller kervilledikten sonra  
montaj öncesinde plastik aksesuarlar  
tokmak yardımıyla takılır.

**UYARI!** Alüminyum profillerin, yukarıda belirtilen birim ağırlıkları yaklaşık olarak hesaplanmıştır. Gerçek birim ağırlıkları, teslimat sırasında yapılan tartım işlemi sonucuna göre hesaplanacaktır.  
**WARNING!** Above mentioned aluminium profiles unit weights have been theoretically calculated. The actual unit weight will be calculated on delivery to put into the invoicing process.

# Sürme Cam Montaj Şeması

## Sliding Glass Assembly Scheme

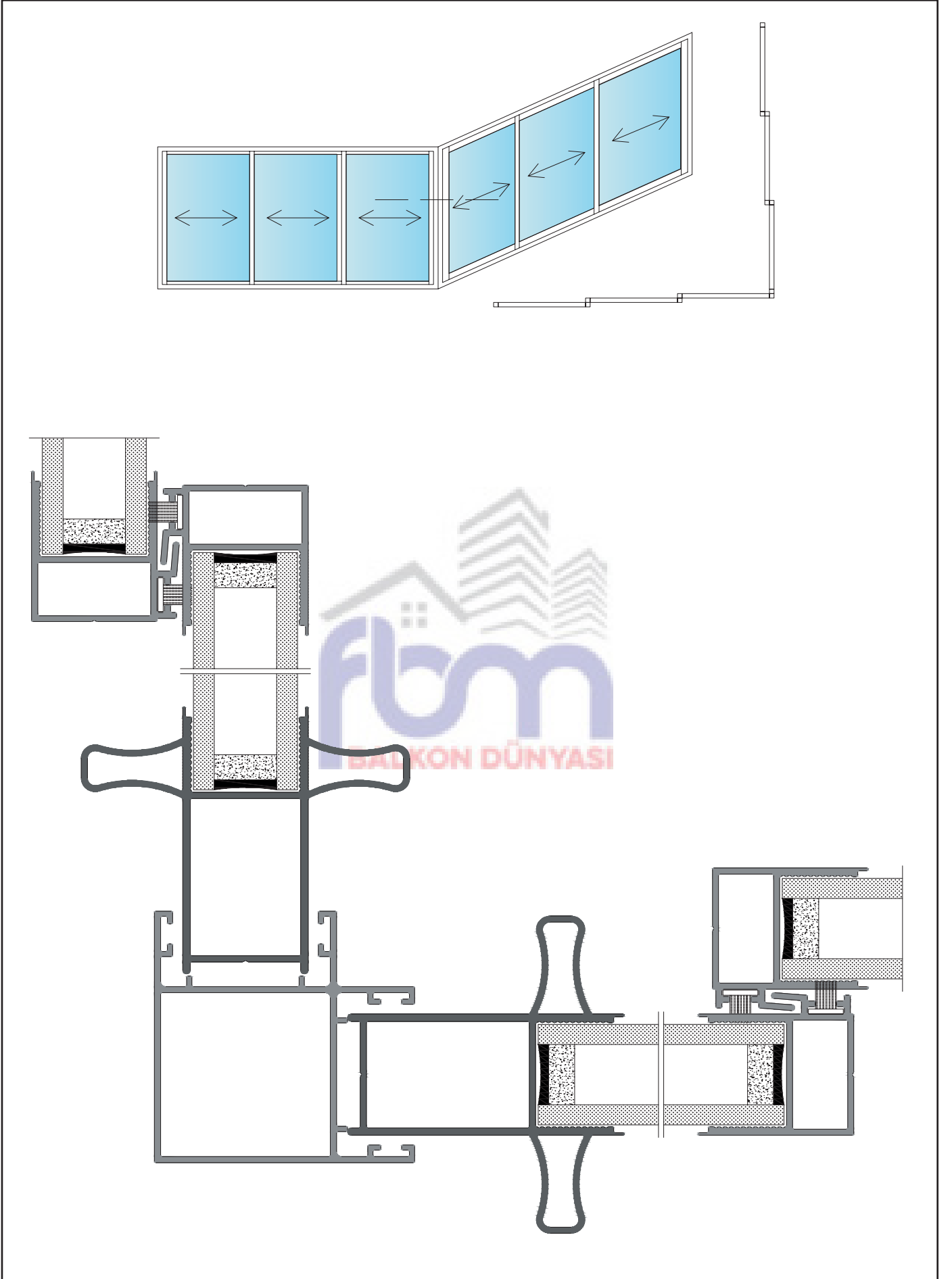

**UYARI!** Alüminyum profillerin, yukarıda belirtilen birim ağırlıkları yaklaşık olarak hesaplanmıştır. Gerçek birim ağırlıkları, teslimat sırasında yapılan tartım işlemi sonucuna göre hesaplanacaktır.  
**WARNING!** Above mentioned aluminium profiles unit weights have been theoretically calculated. The actual unit weight will be calculated on delivery to put into the invoicing process.

# Sürme Cam Montaj Şeması

## Sliding Glass Assembly Scheme

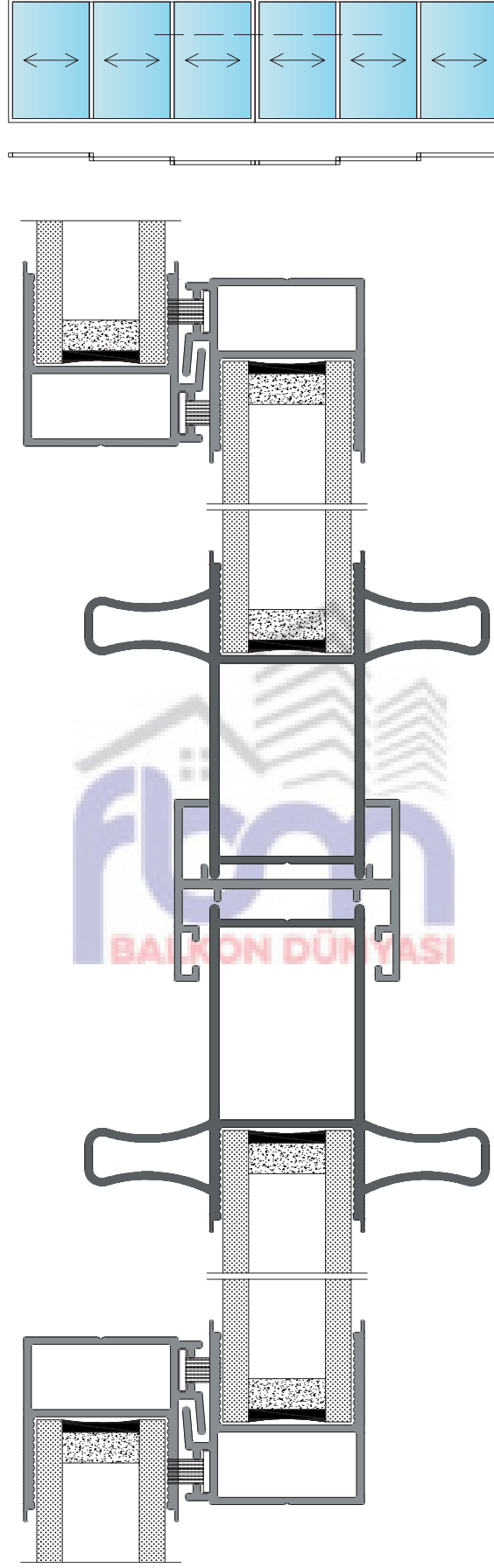

**UYARI!** Alüminyum profillerin, yukarda belirtilen birim ağırlıkları yaklaşık olarak hesaplanmıştır. Gerçek birim ağırlıkları, teslimat sırasında yapılan tartım işlemi sonucuna göre hesaplanacaktır.  
**WARNING!** Above mentioned aluminium profiles unit weights have been theoretically calculated. The actual unit weight will be calculated on delivery to put into the invoicing process.



# Isıcam Eşikli 4'lü Sürme Cam Sistemi

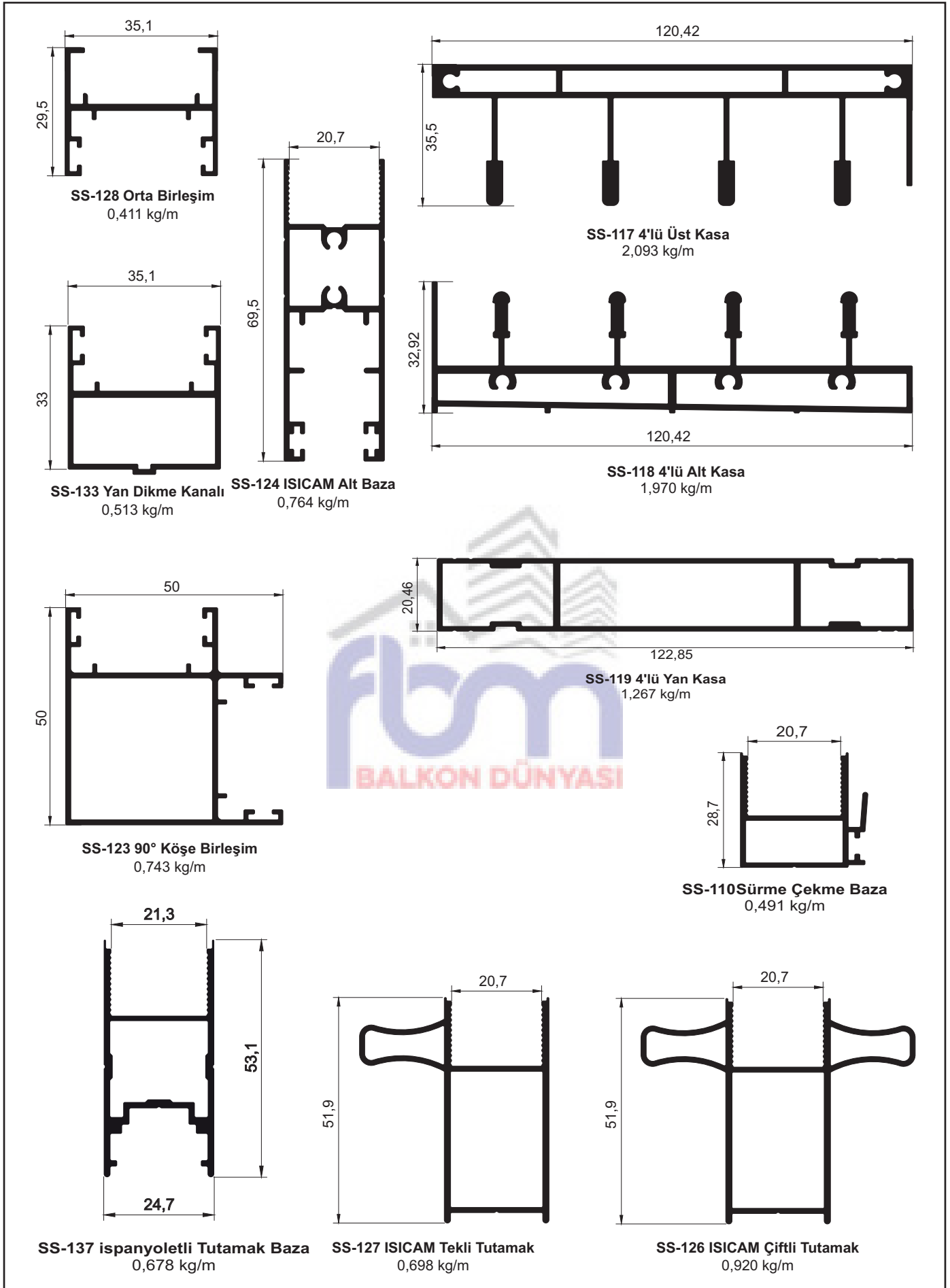

**UYARI!** Alüminyum profillerin, yukarıda belirtilen birim ağırlıkları yaklaşık olarak hesaplanmıştır. Gerçek birim ağırlıkları, teslimat sırasında yapılan tartım işlemi sonucuna göre hesaplanacaktır.  
**WARNING!** Above mentioned aluminium profiles unit weights have been theoretically calculated. The actual unit weight will be calculated on delivery to put into the invoicing process.

# Sürme Cam Sistemleri Aksesuar

## Accessories

Eşikli 4'lü Sürme (SA-SET-2) Aksesuarı	Açıklama	Adet	Birim	Kod	
	4'lü Alt Köşe Takoza (Sağ ve Sol)	Tek Tip Plastik	2	Adet	SA-01
	4'lü Üst Köşe Takoza (Sağ ve Sol)	Tek Tip Plastik	2	Adet	SA-02
	Üst Dikey U	Tek Tip Plastik	2	Adet	SA-10
	Alt Dikey U	Tek Tip Plastik	2	Adet	SA-11
	Tutamak Tapası (Sağ ve Sol)	Tek Tip Plastik	4	Adet	SA-05
	Cam Kapama	Tek Tip Plastik	16	Adet	SA-06
	Teker	Tek Tip	8	Adet	SA-07
	Üst Tozluk	Tek Tip Plastik	3	Adet	SA-08
	Alt Tozluk	Tek Tip Plastik	3	Adet	SA-09

# Isıcam Eşikli 5'li Sürme Cam Sistemi

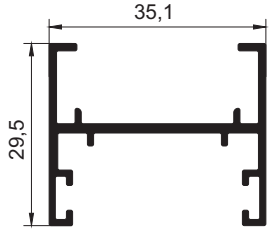

**SS-128 Orta Birleşim**  
0,411 kg/m

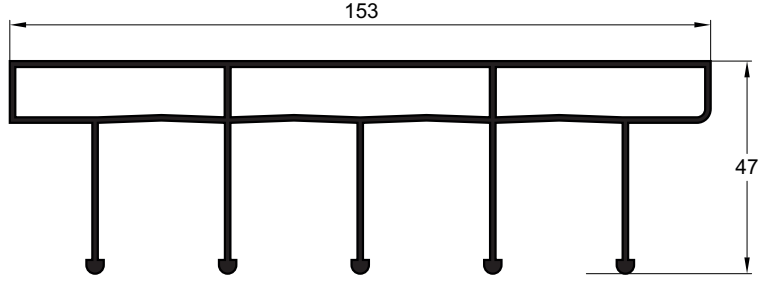

**SS-140 5'li Üst Kasa**  
1,800 kg/m

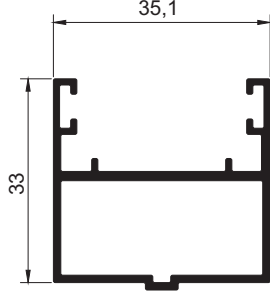

**SS-133 Yan Dikme Kanalı**  
0,513 kg/m

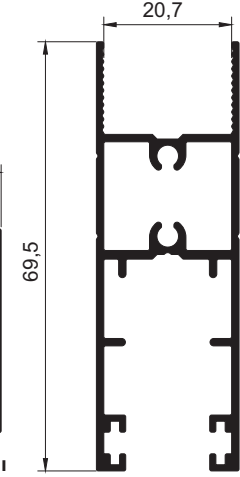

**SS-124 ISICAM Alt Baza**  
0,764 kg/m

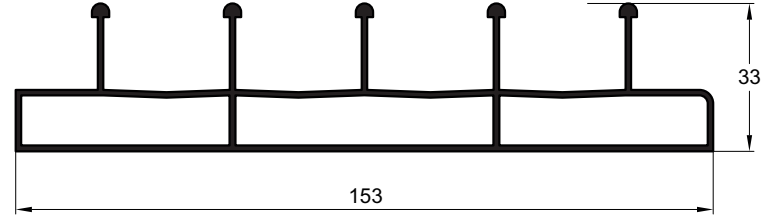

**SS-141 5'li Alt Kasa**  
1,572 kg/m

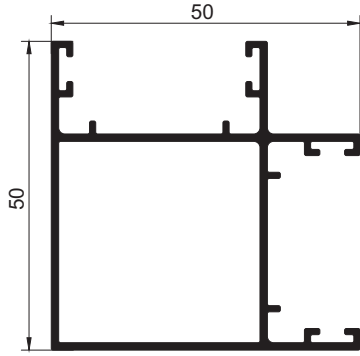

**SS-123 90° Köşe Birleşim**  
0,743 kg/m

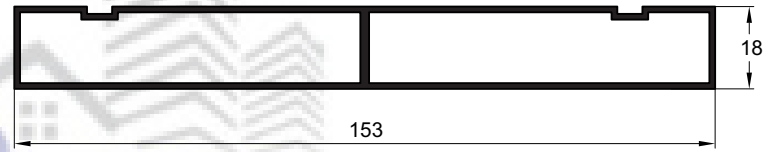

**SS-142 5'li Yan Kasa**  
1,267 kg/m

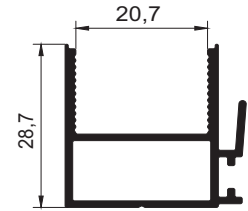

**SS-110 Sürme Çekme Baza**  
0,491 kg/m

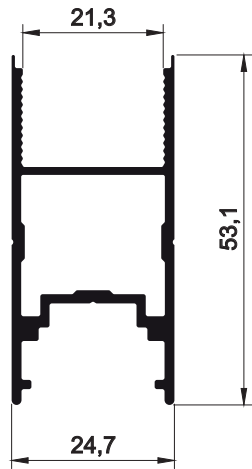

**SS-137 İspanyoletili Tutamak Baza**  
0,678 kg/m

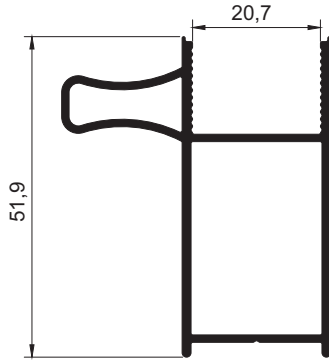

**SS-127 ISICAM Tekli Tutamak**  
0,698 kg/m

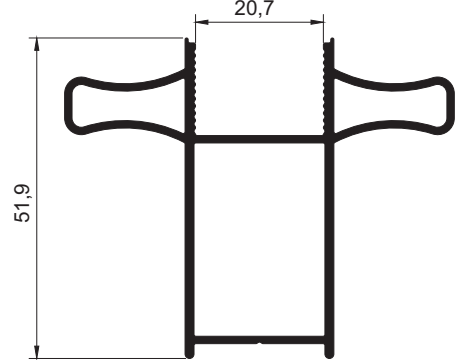

**SS-126 ISICAM Çiftli Tutamak**  
0,920 kg/m

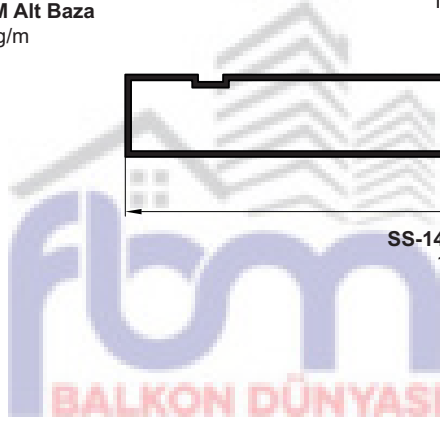

# Sürme Cam Sistemleri Aksesuar

## Accessories

Eşikli 5'li Sürme (SA-SET-7) Aksesuarı	Açıklama	Adet	Birim	Kod	
	5'li Alt - Üst Köşe Takoza (Sağ ve Sol)	Tek Tip Plastik	4	Adet	SA-16
	Üst Dikey U	Tek Tip Plastik	2	Adet	SA-10
	Alt Dikey U	Tek Tip Plastik	2	Adet	SA-11
	Tutamak Tapası (Sağ ve Sol)	Tek Tip Plastik	4	Adet	SA-05
	Cam Kapama	Tek Tip Plastik	20	Adet	SA-06
	Teker	Tek Tip	10	Adet	SA-07
	Üst Tozluk	Tek Tip Plastik	4	Adet	SA-08
	Alt Tozluk	Tek Tip Plastik	4	Adet	SA-09

# Tek Cam Eşikli 2'li Sürme Cam Sistemi

## Triple Single Glass Sliding System

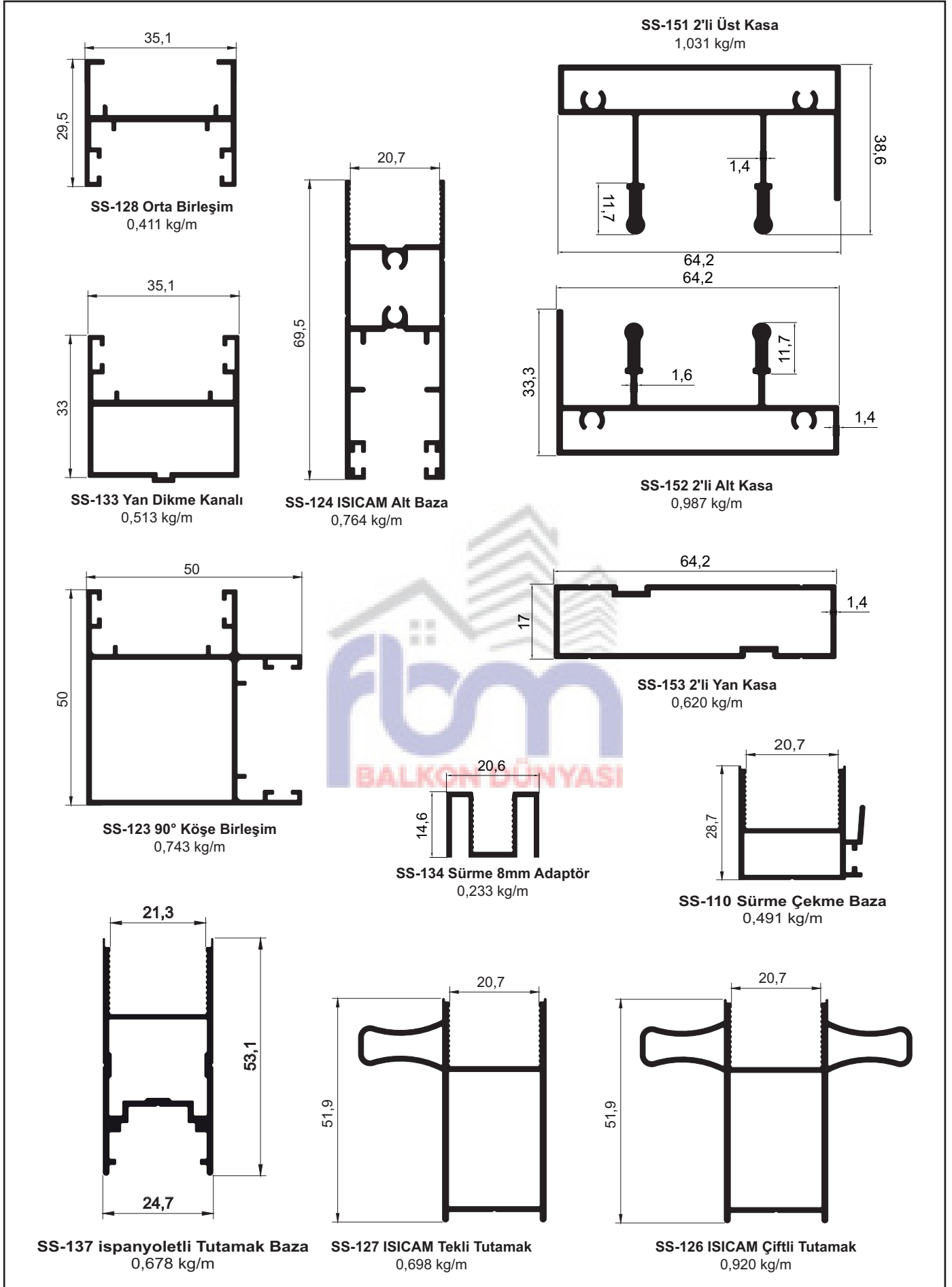

**UYARI!** Alüminyum profillerin, yukarıda belirtilen birim ağırlıkları yaklaşık olarak hesaplanmıştır. Gerçek birim ağırlıkları, teslimat sırasında yapılan tartım işlemi sonucuna göre hesaplanacaktır.  
**WARNING!** Above mentioned aluminium profiles unit weights have been theoretically calculated. The actual unit weight will be calculated on delivery to put into the invoicing process.

# Sürme Cam Sistemleri Aksesuar

## Accessories

Eşikli 2'li Sürme (SA-SET-9) Aksesuarı	Açıklama	Adet	Birim	Kod	
	2'li Alt Köşe Takoza (Sağ ve Sol)	Tek Tip Plastik	2	Adet	SA-51
	2'li Üst Köşe Takoza (Sağ ve Sol)	Tek Tip Plastik	2	Adet	SA-52
	Üst Dikey U	Tek Tip Plastik	2	Adet	SA-10
	Alt Dikey U	Tek Tip Plastik	2	Adet	SA-11
	Tutamak Tapası (Sağ ve Sol)	Tek Tip Plastik	4	Adet	SA-05
	Cam Kapama	Tek Tip Plastik	8	Adet	SA-06
	Teker	Tek Tip	4	Adet	SA-07
	Üst Tozluk	Tek Tip Plastik	2	Adet	SA-08
	Alt Tozluk	Tek Tip Plastik	2	Adet	SA-09

# Tek Cam Eşikli 3'lü Sürme Cam Sistemi

## Triple Single Glass Sliding System

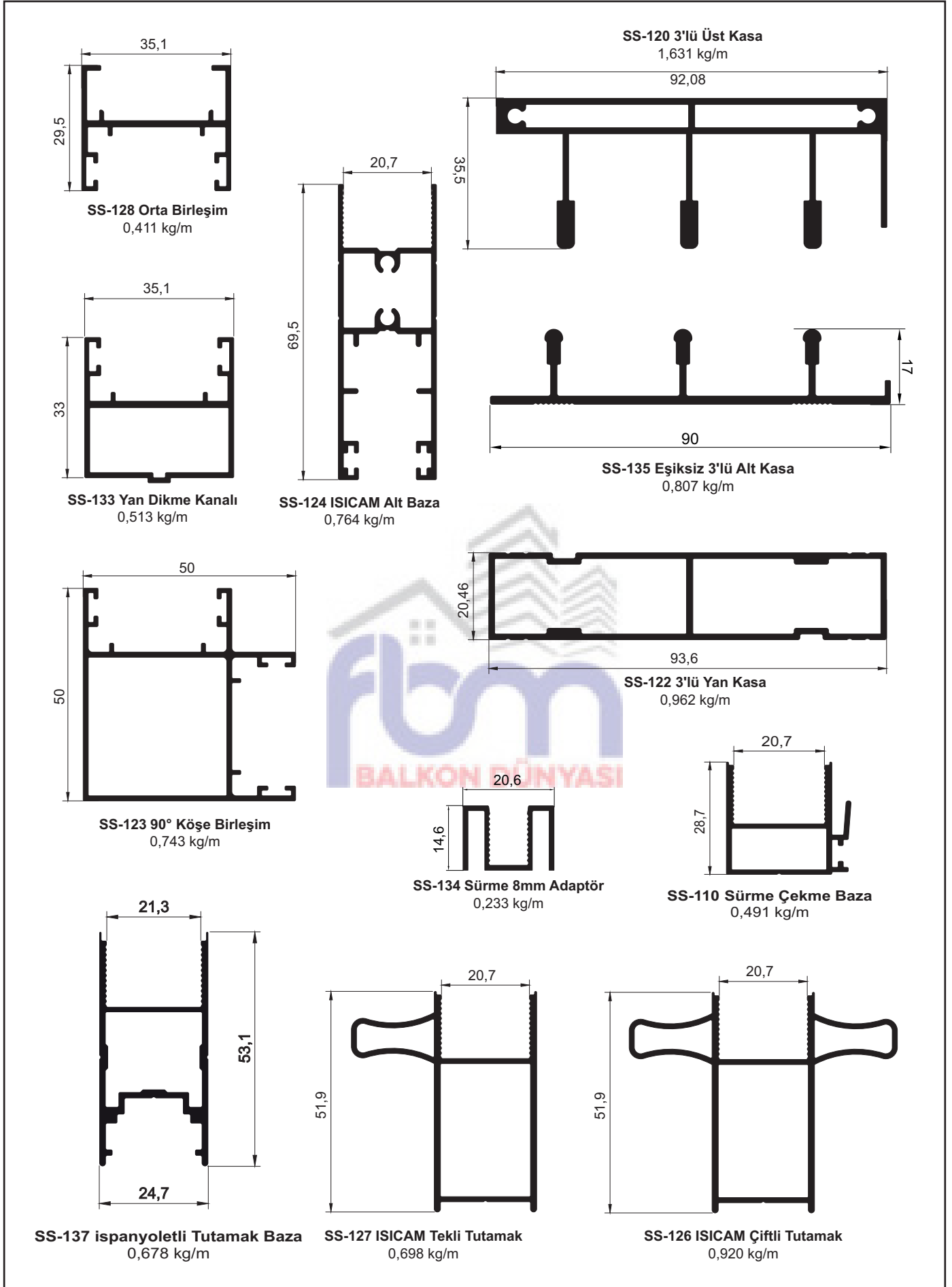

**UYARI!** Alüminyum profillerin, yukarıda belirtilen birim ağırlıkları yaklaşık olarak hesaplanmıştır. Gerçek birim ağırlıkları, teslimat sırasında yapılan tartım işlemi sonucuna göre hesaplanacaktır.  
**WARNING!** Above mentioned aluminium profiles unit weights have been theoretically calculated. The actual unit weight will be calculated on delivery to put into the invoicing process.

# Sürme Cam Sistemleri Aksesuar

## Accessories

Eşikli 3'lü Sürme (SA-SET-1) Aksesuarı	Açıklama	Adet	Birim	Kod	
	3'lü Alt Köşe Takoza (Sağ ve Sol)	Tek Tip Plastik	2	Adet	SA-03
	3'lü Üst Köşe Takoza (Sağ ve Sol)	Tek Tip Plastik	2	Adet	SA-04
	Üst Dikey U	Tek Tip Plastik	2	Adet	SA-10
	Alt Dikey U	Tek Tip Plastik	2	Adet	SA-11
	Tutamak Tapası (Sağ ve Sol)	Tek Tip Plastik	4	Adet	SA-05
	Cam Kapama	Tek Tip Plastik	12	Adet	SA-06
	Teker	Tek Tip	6	Adet	SA-07
	Üst Tozluk	Tek Tip Plastik	2	Adet	SA-08
	Alt Tozluk	Tek Tip Plastik	2	Adet	SA-09

# Tek Cam Eşikli 4'lü Sürme Cam Sistemi

## Four Single Glass Sliding System

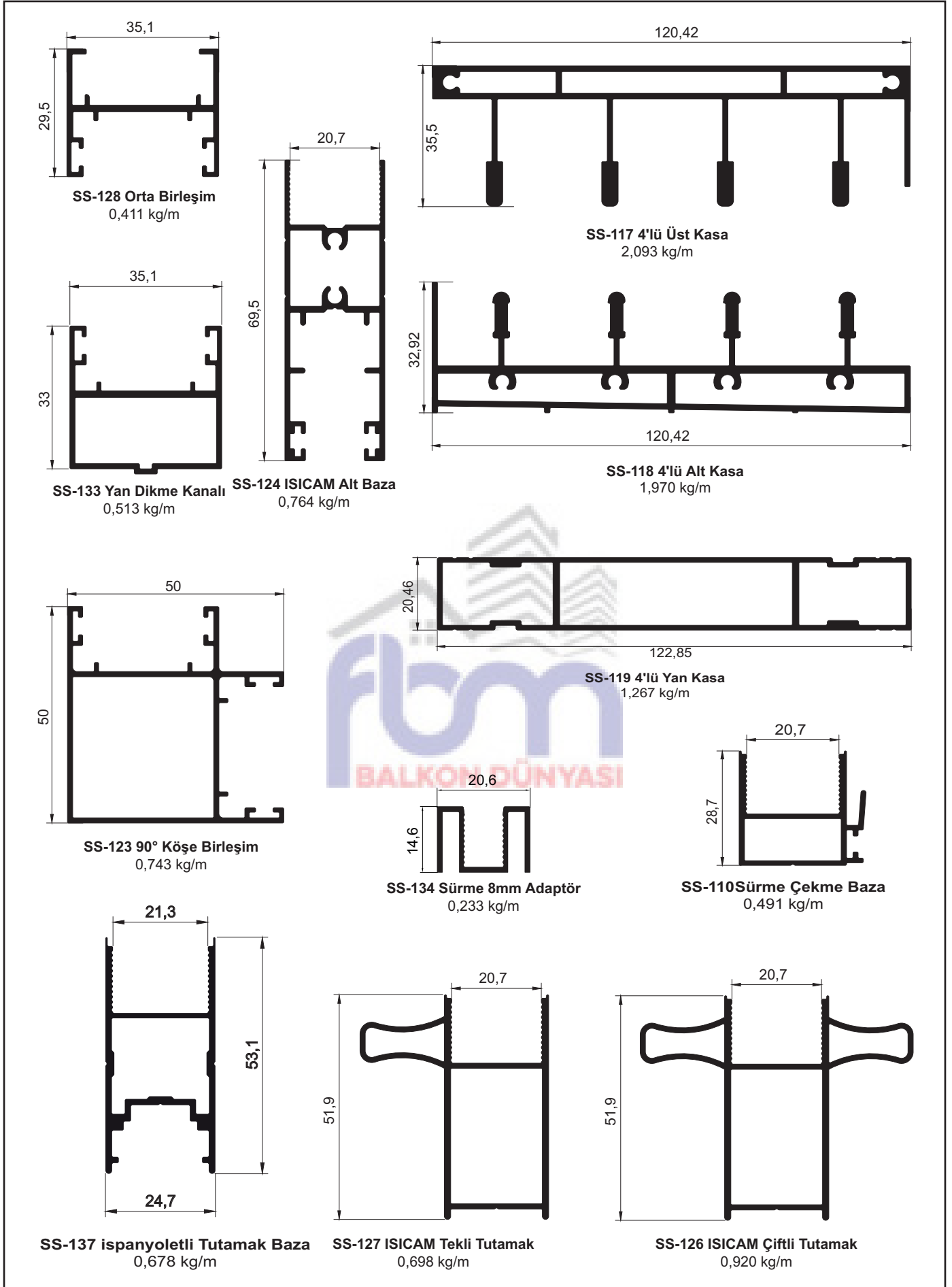

**UYARI!** Alüminyum profillerin, yukarıda belirtilen birim ağırlıkları yaklaşık olarak hesaplanmıştır. Gerçek birim ağırlıkları, teslimat sırasında yapılan tartım işlemi sonucuna göre hesaplanacaktır.  
**WARNING!** Above mentioned aluminium profiles unit weights have been theoretically calculated. The actual unit weight will be calculated on delivery to put into the invoicing process.

# Sürme Cam Sistemleri Aksesuar

## Accessories

Eşikli 4'lü Sürme (SA-SET-2) Aksesuarı	Açıklama	Adet	Birim	Kod	
	4'lü Alt Köşe Takoza (Sağ ve Sol)	Tek Tip Plastik	2	Adet	SA-01
	4'lü Üst Köşe Takoza (Sağ ve Sol)	Tek Tip Plastik	2	Adet	SA-02
	Üst Dikey U	Tek Tip Plastik	2	Adet	SA-10
	Alt Dikey U	Tek Tip Plastik	2	Adet	SA-11
	Tutamak Tapası (Sağ ve Sol)	Tek Tip Plastik	4	Adet	SA-05
	Cam Kapama	Tek Tip Plastik	16	Adet	SA-06
	Teker	Tek Tip	8	Adet	SA-07
	Üst Tozluk	Tek Tip Plastik	3	Adet	SA-08
	Alt Tozluk	Tek Tip Plastik	3	Adet	SA-09

# Tek Cam Eşikli 5'li Sürme Cam Sistemi

## Triple Single Glass Sliding System

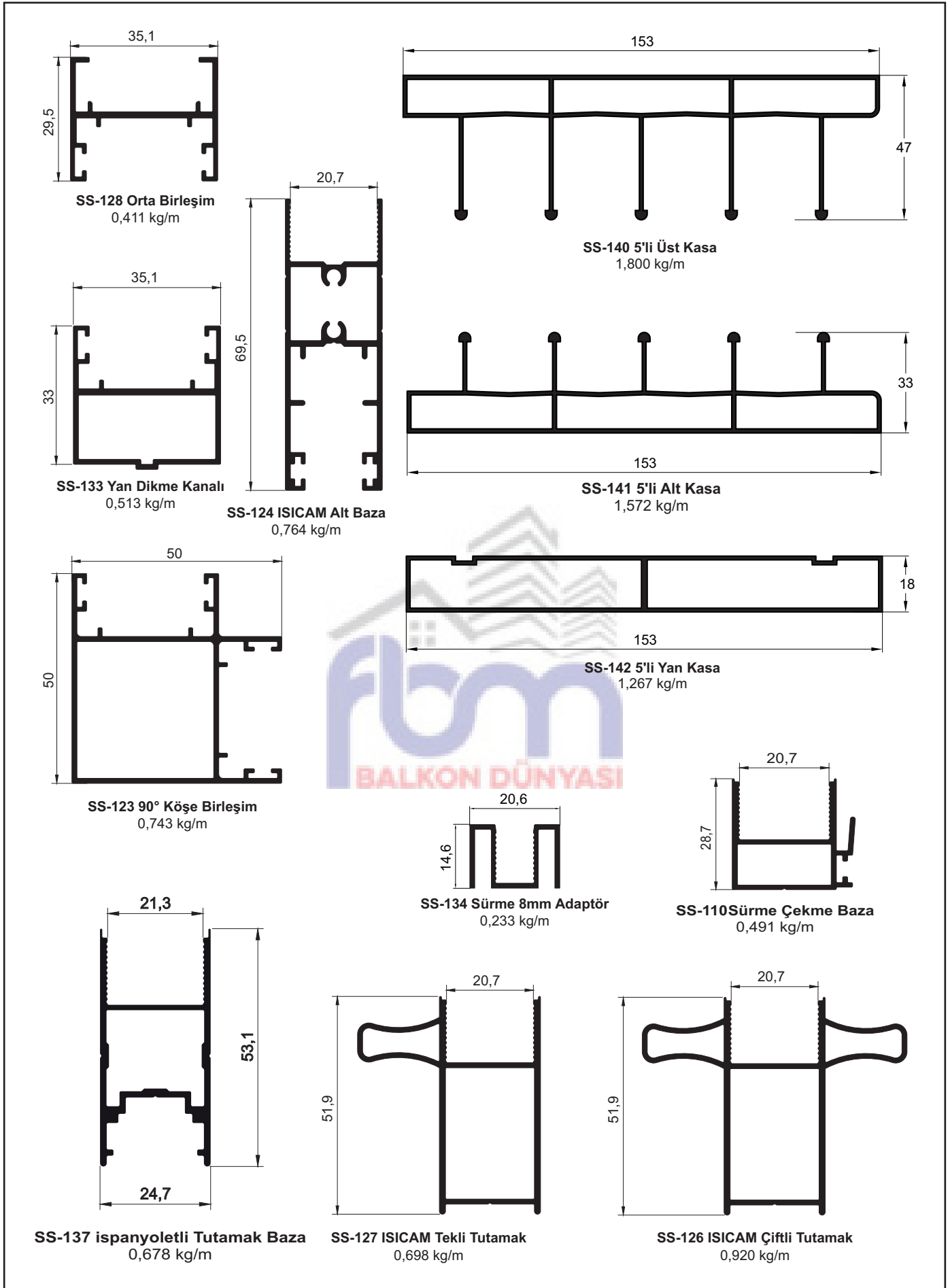

**UYARI!** Alüminyum profillerin, yukarıda belirtilen birim ağırlıkları yaklaşık olarak hesaplanmıştır. Gerçek birim ağırlıkları, teslimat sırasında yapılan tartım işlemi sonucuna göre hesaplanacaktır.  
**WARNING!** Above mentioned aluminium profiles unit weights have been theoretically calculated. The actual unit weight will be calculated on delivery to put into the invoicing process.

# Sürme Cam Sistemleri Aksesuar

## Accessories

Eşikli 5'li Sürme (SA-SET-7) Aksesuarı	Açıklama	Adet	Birim	Kod	
	5'li Alt - Üst Köşe Takoza (Sağ ve Sol)	Tek Tip Plastik	4	Adet	SA-16
	Üst Dikey U	Tek Tip Plastik	2	Adet	SA-10
	Alt Dikey U	Tek Tip Plastik	2	Adet	SA-11
	Tutamak Tapası (Sağ ve Sol)	Tek Tip Plastik	4	Adet	SA-05
	Cam Kapama	Tek Tip Plastik	20	Adet	SA-06
	Teker	Tek Tip	10	Adet	SA-07
	Üst Tozluk	Tek Tip Plastik	4	Adet	SA-08
	Alt Tozluk	Tek Tip Plastik	4	Adet	SA-09

# Isıcam Eşiksiz 3'lü Sürme Cam Sistemi

Triple Double Glazed Sliding Glass System (without threshold)

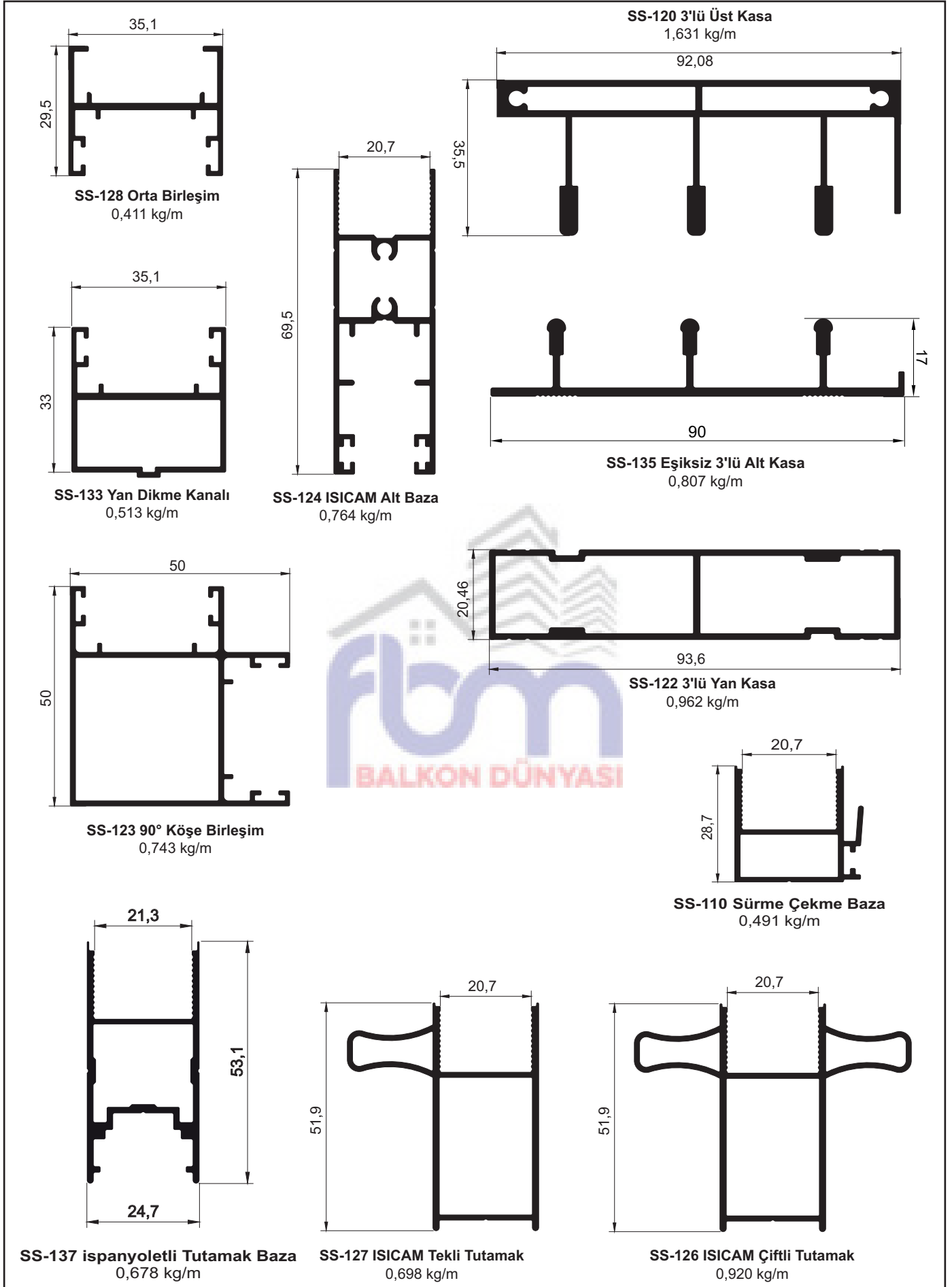

**UYARI!** Alüminyum profillerin, yukarıda belirtilen birim ağırlıkları yaklaşık olarak hesaplanmıştır. Gerçek birim ağırlıkları, teslimat sırasında yapılan tartım işlemi sonucuna göre hesaplanacaktır.  
**WARNING!** Above mentioned aluminium profiles unit weights have been theoretically calculated. The actual unit weight will be calculated on delivery to put into the invoicing process.

# Sürme Cam Sistemleri Aksesuar

## Accessories

Eşiksiz 3'lü Sürme (SA-SET-3) Aksesuarı	Açıklama	Adet	Birim	Kod	
	3'lü Alt Köşe Takoğu (Sağ ve Sol)	Tek Tip Plastik	2	Adet	SA-14
	3'lü Üst Köşe Takoğu (Sağ ve Sol)	Tek Tip Plastik	2	Adet	SA-04
	Üst Dikey U	Tek Tip Plastik	2	Adet	SA-10
	Alt Dikey U	Tek Tip Plastik	2	Adet	SA-11
	Tutamak Tapası (Sağ ve Sol)	Tek Tip Plastik	4	Adet	SA-05
	Cam Kapama	Tek Tip Plastik	12	Adet	SA-06
	Teker	Tek Tip	6	Adet	SA-07
	Üst Tozluk	Tek Tip Plastik	2	Adet	SA-08

# Isıcam Eşiksiz 4'lü Sürme Cam Sistemi

## Four Double Glazed Sliding System (without threshold)

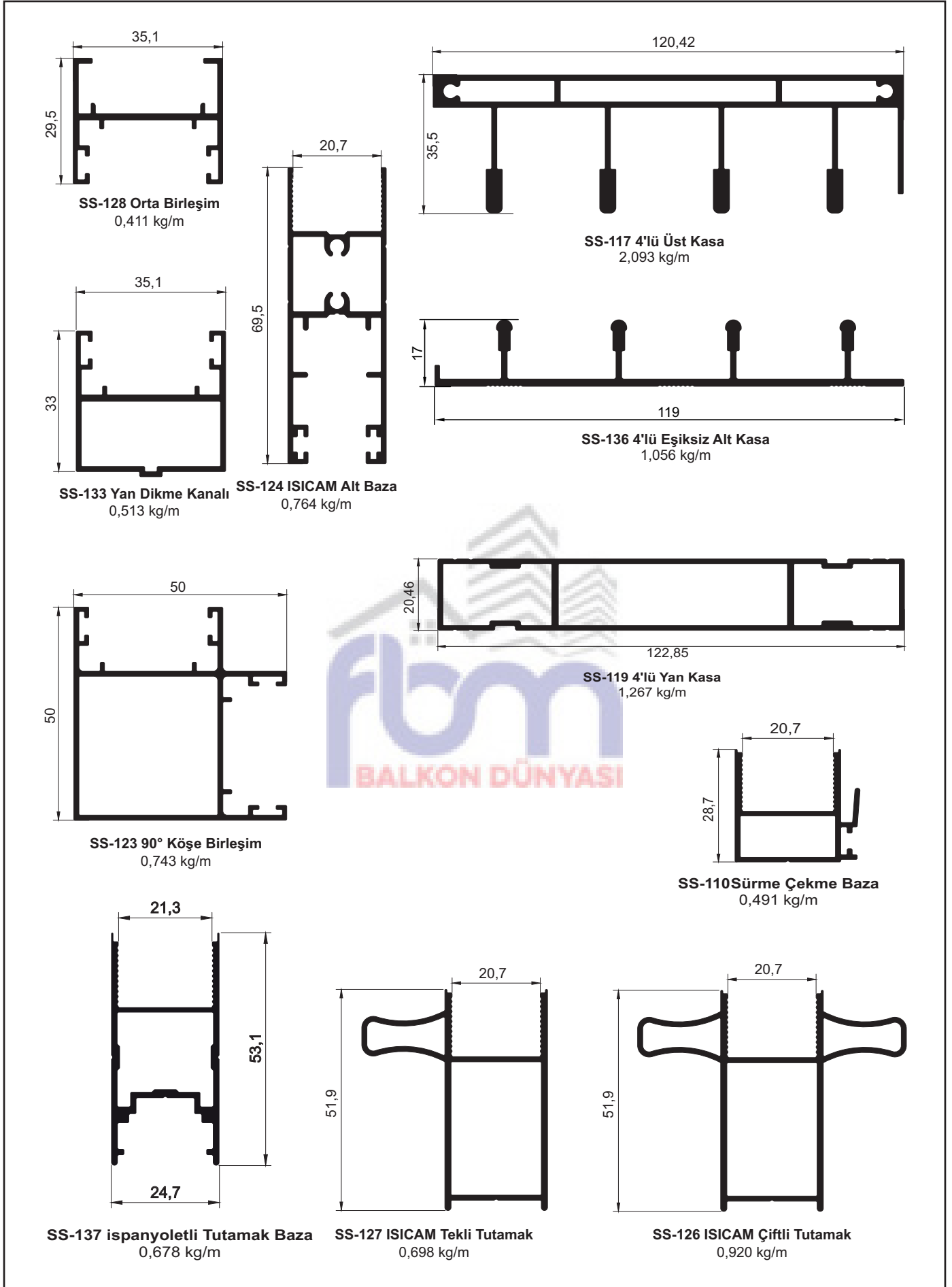

**UYARI!** Alüminyum profillerin, yukarıda belirtilen birim ağırlıkları yaklaşık olarak hesaplanmıştır. Gerçek birim ağırlıkları, teslimat sırasında yapılan tartım işlemi sonucuna göre hesaplanacaktır.  
**WARNING!** Above mentioned aluminium profiles unit weights have been theoretically calculated. The actual unit weight will be calculated on delivery to put into the invoicing process.

# Sürme Cam Sistemleri Aksesuar

## Accessories

Eşiksiz 4'lü Sürme (SA-SET-4) Aksesuarı	Açıklama	Adet	Birim	Kod	
	4'lü Alt Köşe Takoğu (Sağ ve Sol)	Tek Tip Plastik	2	Adet	SA-15
	4'lü Üst Köşe Takoğu (sağ ve sol)	Tek Tip Plastik	2	Adet	SA-02
	Üst Dikey U	Tek Tip Plastik	2	Adet	SA-10
	Alt Dikey U	Tek Tip Plastik	2	Adet	SA-11
	Tutamak Tapası (sağ ve sol)	Tek Tip Plastik	4	Adet	SA-05
	Cam Kapama	Tek Tip Plastik	16	Adet	SA-06
	Teker	Tek Tip	8	Adet	SA-07
	Üst Tozluk	Tek Tip Plastik	3	Adet	SA-08

# Isıcam Eşiksiz 5'li Sürme Cam Sistemi

## Four Double Glazed Sliding System (without threshold)

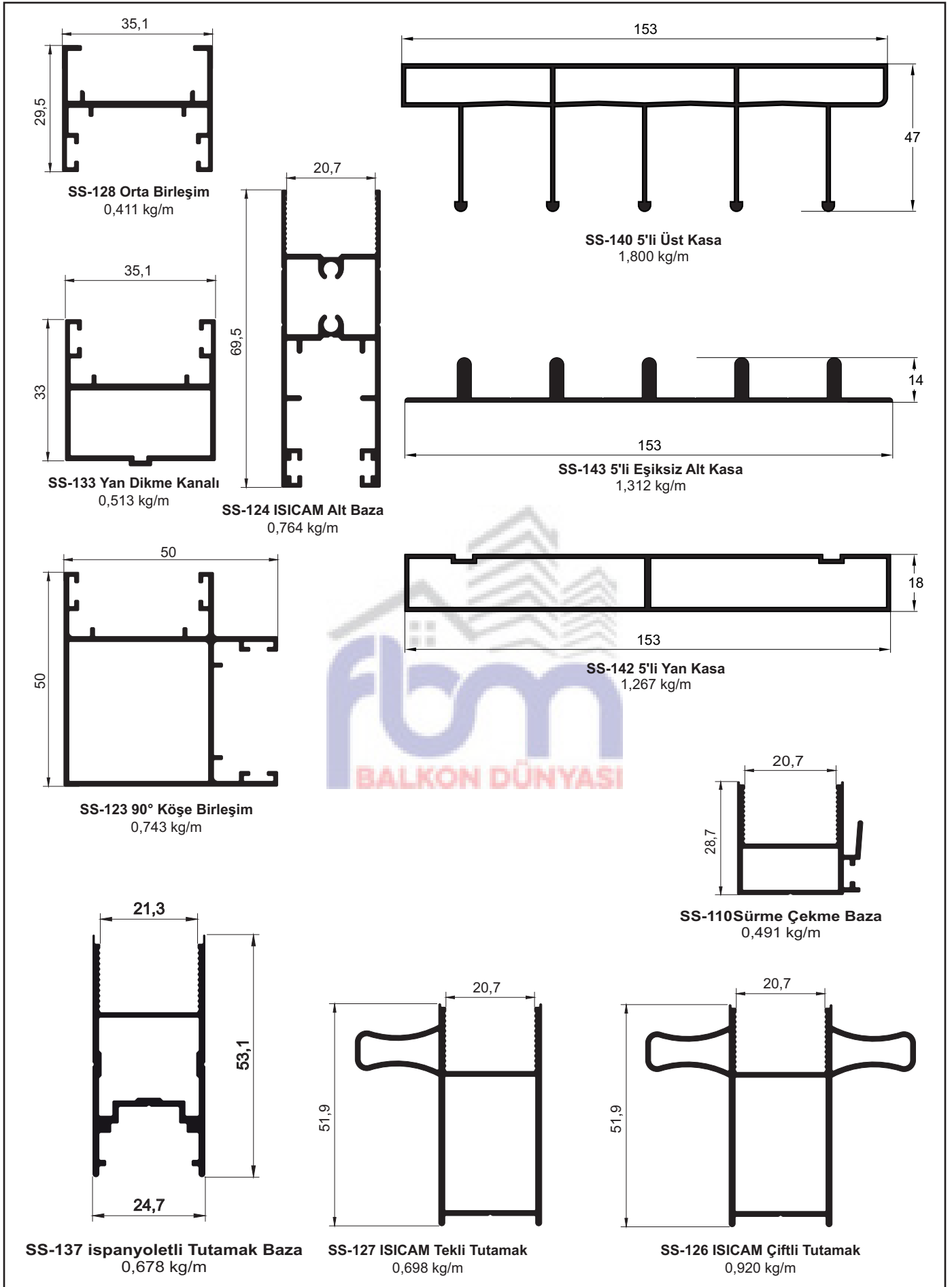

# Sürme Cam Sistemleri Aksesuar

## Accessories

Eşiksiz 5'li Sürme (SA-SET-8) Aksesuarı	Açıklama	Adet	Birim	Kod	
	5'li Alt Köşe Takoğu (Sağ ve Sol)	Tek Tip Plastik	2	Adet	SA-17
	5'li Üst Köşe Takoğu (Sağ - Sol)	Tep Tip Plastik	2	Adet	SA-16
	Üst Dikey U	Tek Tip Plastik	2	Adet	SA-10
	Alt Dikey U	Tek Tip Plastik	2	Adet	SA-11
	Tutamak Tapası (Sağ ve Sol)	Tek Tip Plastik	4	Adet	SA-05
	Cam Kapama	Tek Tip Plastik	20	Adet	SA-06
	Teker	Tek Tip	10	Adet	SA-07
	Üst Tozluk	Tek Tip Plastik	4	Adet	SA-08

# Tek Cam Eşiksiz 3'lü Sürme Cam Sistemi

## Triple Single Glass Sliding System

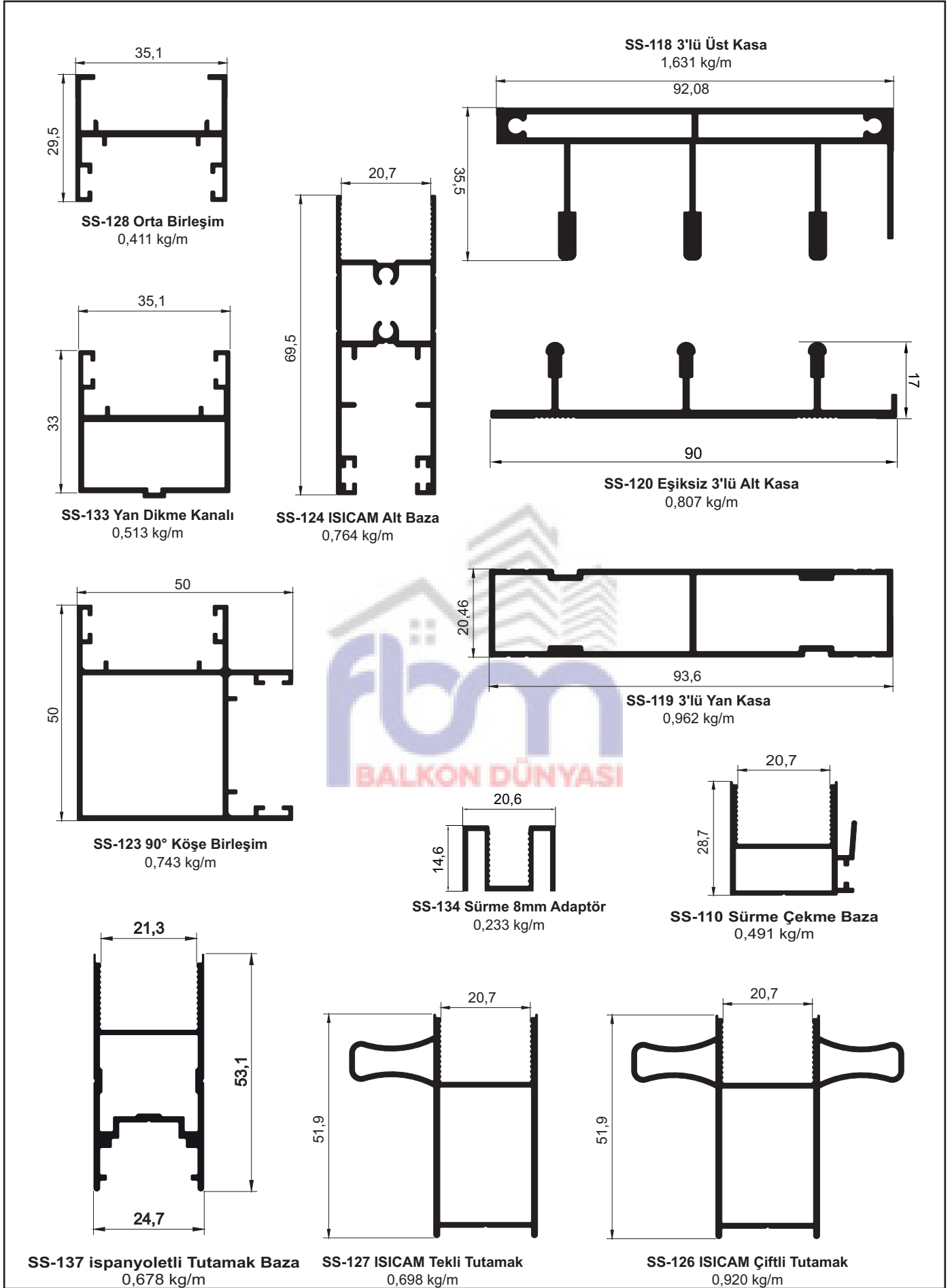

**UYARI!** Alüminyum profillerin, yukarıda belirtilen birim ağırlıkları yaklaşık olarak hesaplanmıştır. Gerçek birim ağırlıkları, teslimat sırasında yapılan tartım işlemi sonucuna göre hesaplanacaktır.  
**WARNING!** Above mentioned aluminium profiles unit weights have been theoretically calculated. The actual unit weight will be calculated on delivery to put into the invoicing process.

# Sürme Cam Sistemleri Aksesuar

## Accessories

Eşiksiz 3'lü Sürme (SA-SET-3) Aksesuarı	Açıklama	Adet	Birim	Kod	
	3'lü Alt Köşe Takoğu (Sağ ve Sol)	Tek Tip Plastik	2	Adet	SA-14
	3'lü Üst Köşe Takoğu (Sağ ve Sol)	Tek Tip Plastik	2	Adet	SA-04
	Üst Dikey U	Tek Tip Plastik	2	Adet	SA-10
	Alt Dikey U	Tek Tip Plastik	2	Adet	SA-11
	Tutamak Tapası (Sağ ve Sol)	Tek Tip Plastik	4	Adet	SA-05
	Cam Kapama	Tek Tip Plastik	12	Adet	SA-06
	Teker	Tek Tip	6	Adet	SA-07
	Üst Tozluk	Tek Tip Plastik	2	Adet	SA-08

# Tek Cam Eşiksiz 4'lü Sürme Cam Sistemi

## Four Single Glass Sliding System

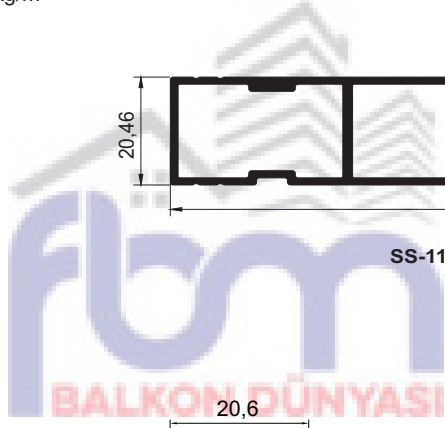
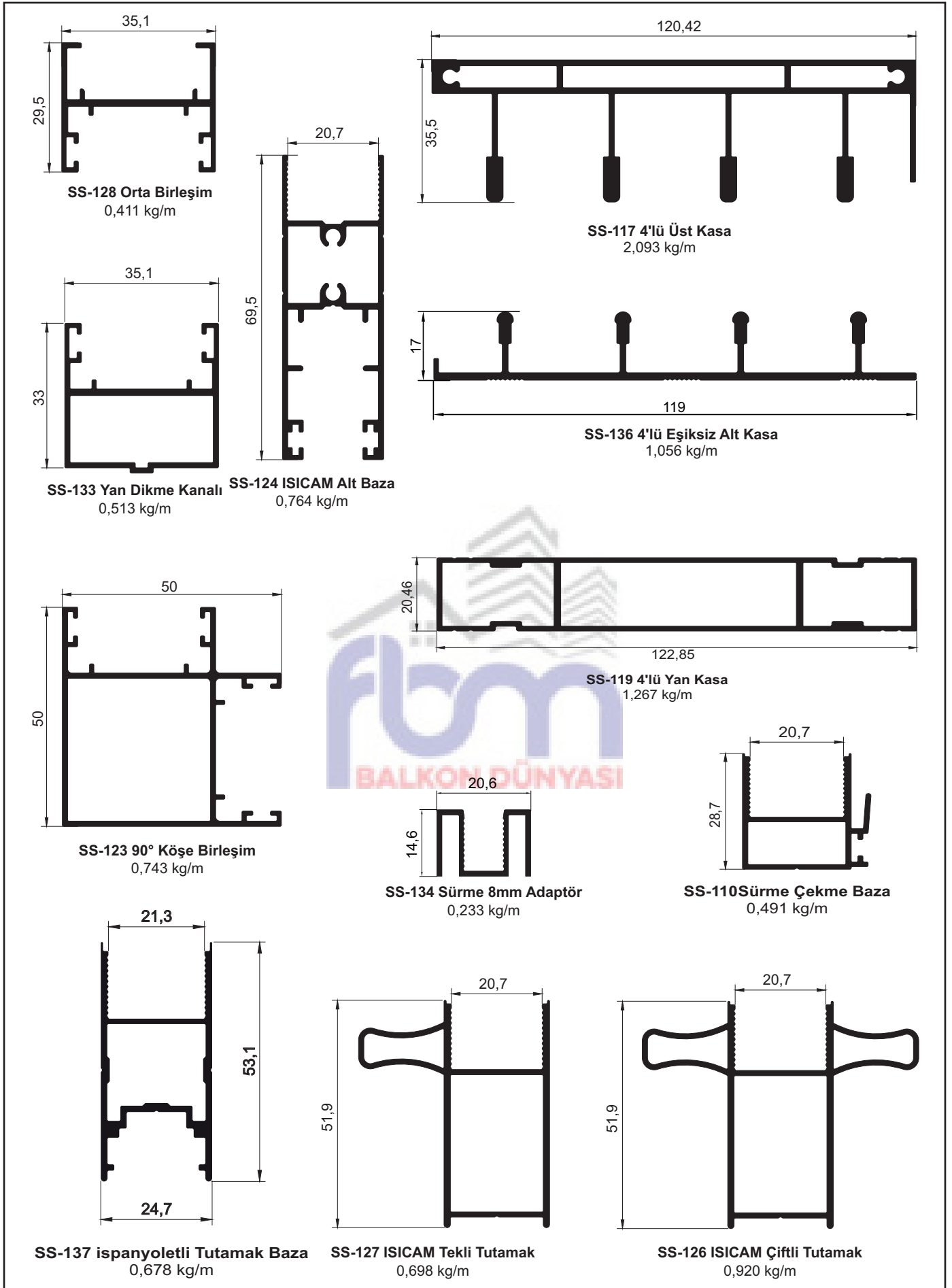

**UYARI!** Alüminyum profillerin, yukarıda belirtilen birim ağırlıkları yaklaşık olarak hesaplanmıştır. Gerçek birim ağırlıkları, teslimat sırasında yapılan tartım işlemi sonucuna göre hesaplanacaktır.  
**WARNING!** Above mentioned aluminium profiles unit weights have been theoretically calculated. The actual unit weight will be calculated on delivery to put into the invoicing process.

# Sürme Cam Sistemleri Aksesuar

## Accessories

Eşiksiz 4'lü Sürme (SA-SET-4) Aksesuarı	Açıklama	Adet	Birim	Kod	
	4'lü Alt Köşe Takoğu (Sağ ve Sol)	Tek Tip Plastik	2	Adet	SA-15
	4'lü Üst Köşe Takoğu (sağ ve sol)	Tek Tip Plastik	2	Adet	SA-02
	Üst Dikey U	Tek Tip Plastik	2	Adet	SA-10
	Alt Dikey U	Tek Tip Plastik	2	Adet	SA-11
	Tutamak Tapası (sağ ve sol)	Tek Tip Plastik	4	Adet	SA-05
	Cam Kapama	Tek Tip Plastik	16	Adet	SA-06
	Teker	Tek Tip	8	Adet	SA-07
	Üst Tozluk	Tek Tip Plastik	3	Adet	SA-08

# Tek Cam Eşiksiz 5'li Sürme Cam Sistemi

## Triple Single Glass Sliding System

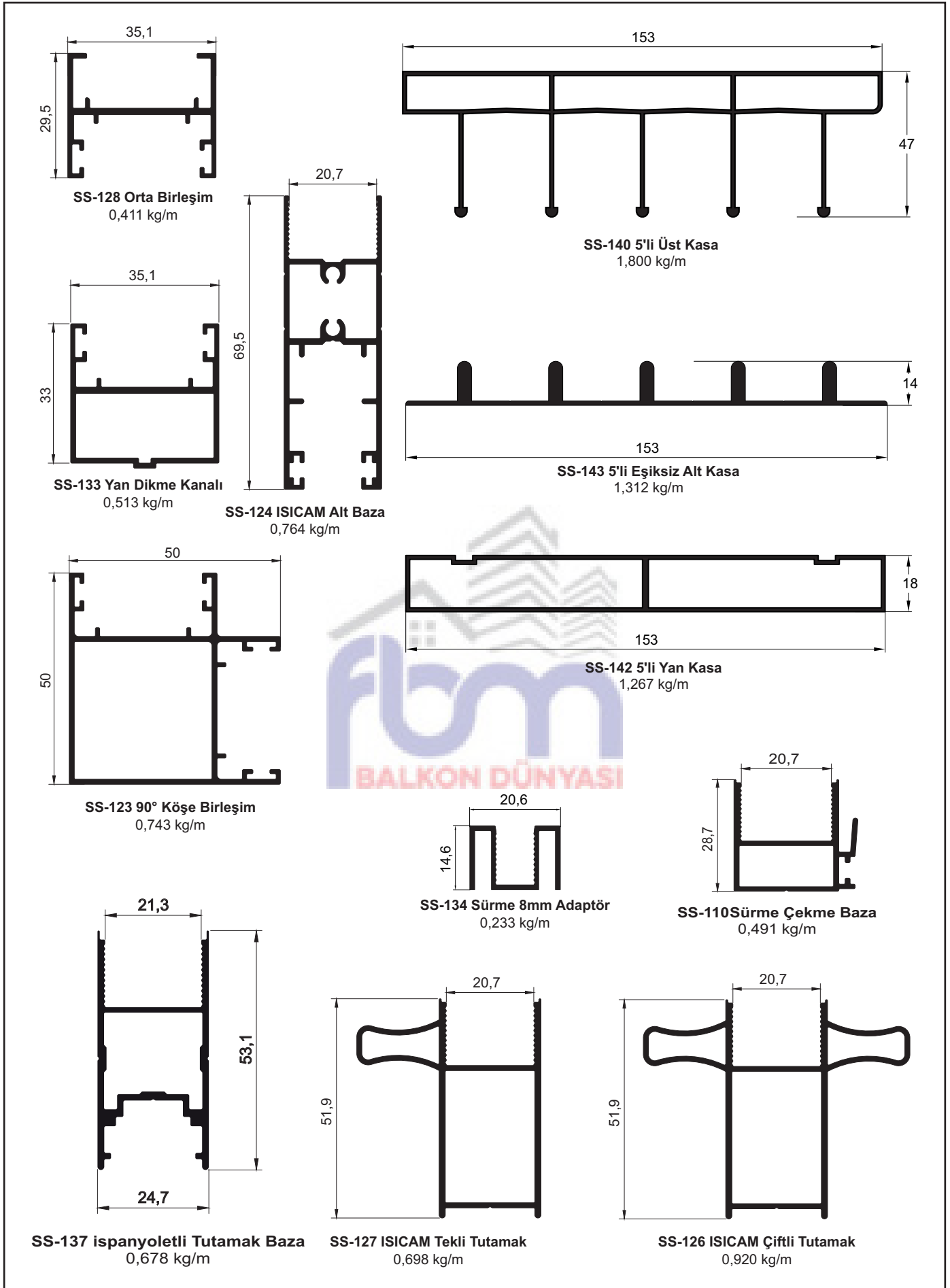





# Sürme Cam Sistemleri Aksesuar

## Accessories

Eşiksiz 5'li Sürme (SA-SET-8) Aksesuarı	Açıklama	Adet	Birim	Kod	
	5'li Alt Köşe Takoğu (Sağ ve Sol)	Tek Tip Plastik	2	Adet	SA-17
	5'li Üst Köşe Takoğu (Sağ - Sol)	Tep Tip Plastik	2	Adet	SA-16
	Üst Dikey U	Tek Tip Plastik	2	Adet	SA-10
	Alt Dikey U	Tek Tip Plastik	2	Adet	SA-11
	Tutamak Tapası (Sağ ve Sol)	Tek Tip Plastik	4	Adet	SA-05
	Cam Kapama	Tek Tip Plastik	20	Adet	SA-06
	Teker	Tek Tip	10	Adet	SA-07
	Üst Tozluk	Tek Tip Plastik	4	Adet	SA-08

# Sürme Cam Sistemleri Aksesuar

## Accessories

4'lü Sürme Kanat Seti (SA-SET-5) Aksesuarı	Açıklama	Adet	Birim	Kod	
	Cam Kapama	Tek Tip Plastik	16	Adet	SA-06
	Teker	Tek Tip	8	Adet	SA-07
	Üst Tozluk	Tek Tip Plastik	3	Adet	SA-08
	Alt Tozluk	Tek Tip Plastik	3	Adet	SA-09

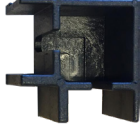
90 Derece Köşe Takoz Seti (Çift Kulp) (SA-SET-6)	Açıklama	Adet	Birim	Kod	
	90 Derece Üst Köşe	Tek Tip Plastik	1	Adet	SA-12
	90 Derece Alt Köşe	Tek Tip Plastik	1	Adet	SA-13

# FBM BALKON DÜNYASI

İvedik OSB Mahallesi 1403.  
Sokak No:12  
Yenimahalle / ANKARA

0312 512 11 18 0552 326 51 51