

# RÜZGAR KIRICI / WINDBREAKER

Rüzgâr Kırıcı Sistemleri, otel, kafe, restoran, konut, teras, alışveriş merkezleri gibi mekânlarda rüzgârın olumsuz etkilerinden korunmanızı sağlayarak yaşam alanlarınızı daha konforlu ve vazgeçilmez hale getirir. Rüzgar Kırıcı Sistem; rüzgârlı havalarda hava akışını oturma seviyesinden yukarıya taşıyarak rüzgârın olumsuz etkilerini azaltır.

Hareketli cam panel yer seviyesinden 180 cm yüksekliğe kadar rüzgârdan korur.

Sistem manuel olarak kullanıma uygundur. Ağırlık dengeleme sistemi sayesinde yükseklik ayarı kolaylıkla yapılabilmektedir.

Rüzgâr Kırıcı, tek başına kullanılabilirdiği gibi yan yana getirilerek de kullanılabilir ve açık alanlarda seperatör görevini üstlenir. Kafe ve restoran gibi işletmelerde masa arasında kullanılan Rüzgar Kırıcı, COVID-19'un bulaşma etkisini azaltabilir.

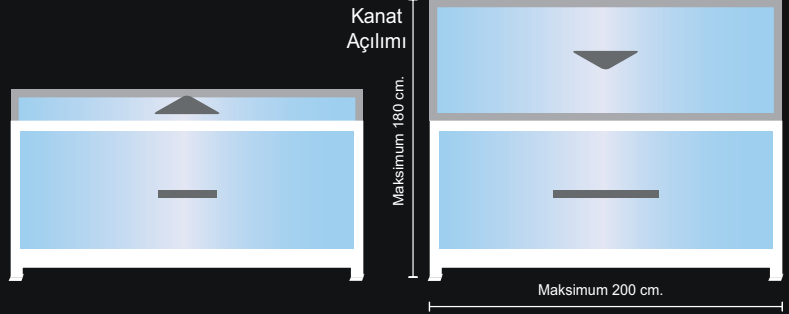

Wind Breaker Systems make living spaces more comfortable and indispensable by protecting you from the negative effects of wind in places such as hotels, cafes, restaurants, residences, terraces and shopping centers. The Wind Breaker System reduces the negative effects of the wind by moving the air flow above the session level in windy weather.

The movable glass panel protects from the wind up to 180 cm above ground level.

The system is suitable for manual use. Height adjustment can be made easily with the weight balancing system.

The Wind Breaker can be used alone or side by side and acts as a separator in open areas. The Wind Breaker, which is used between the tables in businesses such as cafes and restaurants, can reduce the contagion effect of COVID-19.

# Rüzgar Kırıcı (MANUEL)

## Windbreaker

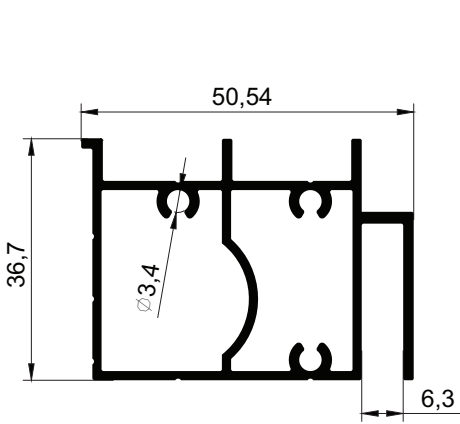

**RK-501 DİKEY BAZA**  
0.946 kg/m

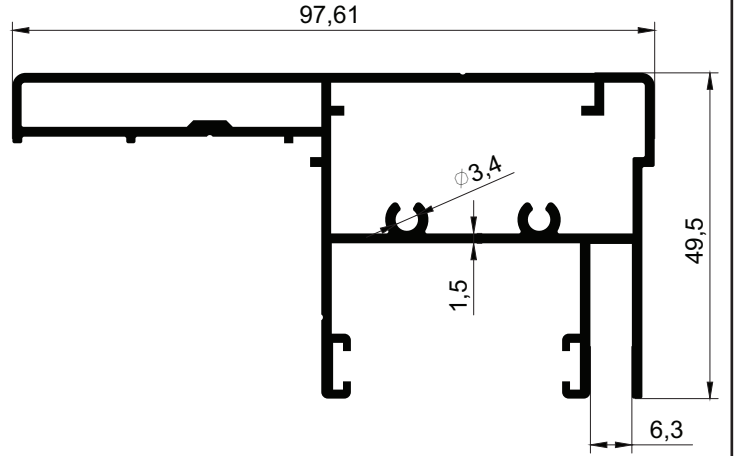

**RK-502 SABİT DİKME**  
1.526 kg/m

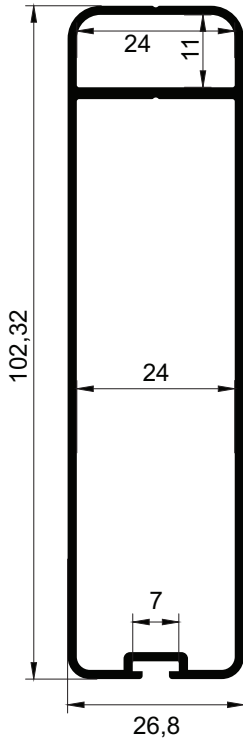

**RK-504 AĞIRLIK**  
1,08 kg/m

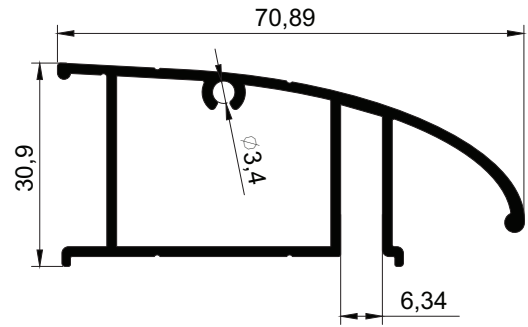

**RK-503 KÜPEŞTE**  
0.806 kg/m

**Not:** Ağırlık Profili için 2 adet 20x10 Lama ve 20x10 silme demir kullanılır.

**UYARI!** Alüminyum profillerin, yukarıda belirtilen birim ağırlıkları yaklaşık olarak hesaplanmıştır. Gerçek birim ağırlıkları, teslimat sırasında yapılan tartım işlemi sonucuna göre hesaplanacaktır.  
**WARNING!** Above mentioned aluminium profiles unit weights have been theoretically calculated. The actual unit weight will be calculated on delivery to put into the invoicing process.

# Rüzgar Kırıcı (**MANUEL/PİSTONLU**) Aksesuar Seti

## Accessories

(RKA-SET-1) Aksesuar/Ürün	Açıklama	Birim	Miktar	Kod	
	Üst Hareketli Kapak	Sağ ve Sol Plastik	Adet	2	RKA-201
	2 mm Çelik Tel Halat	Tek Tip Çelik	Adet 1,25 mt	2	RKA-202
	Halat Yüzük	Tek Tip Çelik	Adet	4	RKA-203
	Üst Sabit Kapak	Sağ ve Sol Plastik	Adet	2	RKA-204
	Ayak	Sağ ve Sol Çelik	Adet	2	RKA-205
	Hareketli Kızak	Tek Tip Plastik	Adet	4	RKA-206
	Halat Makarası	Tek Tip Çelik	Adet	2	RKA-207
	Fren	Tek Tip Çelik	Adet	2	RKA-204

**UYARI!** Alüminyum profillerin, yukarıda belirtilen birim ağırlıkları yaklaşık olarak hesaplanmıştır. Gerçek birim ağırlıkları, teslimat sırasında yapılan tartım işlemi sonucuna göre hesaplanacaktır.  
**WARNING!** Above mentioned aluminium profiles unit weights have been theoretically calculated. The actual unit weight will be calculated on delivery to put into the invoicing process.

# Rüzgar Kırıcı (PİSTONLU)

## Windbreaker

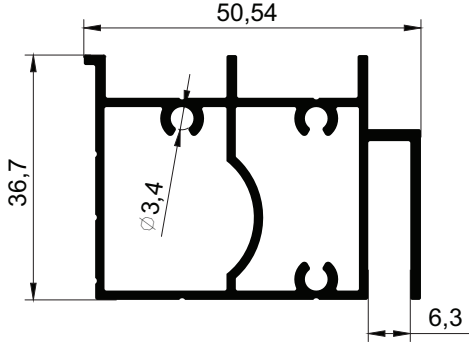

**RK-501 DİKEY BAZA**  
0.946 kg/m

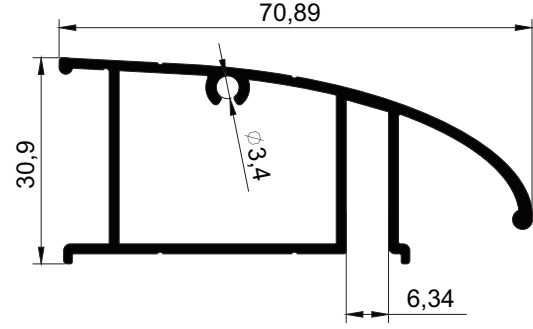

**RK-503 KÜPEŞTE**  
0.806 kg/m

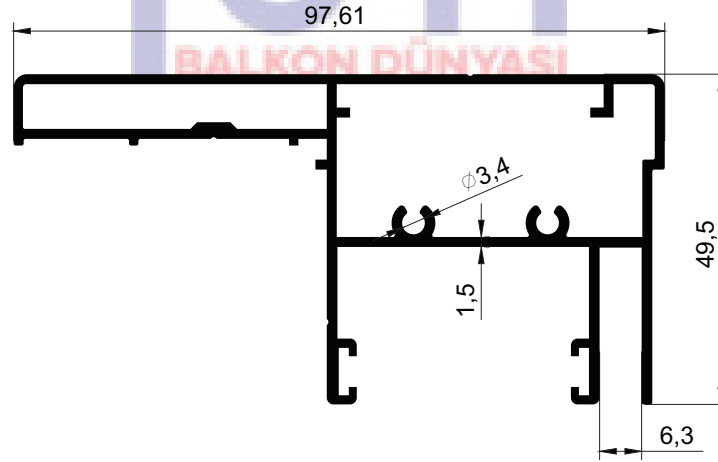





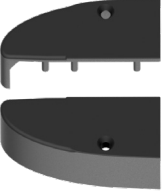

**RK-502 SABİT DİKME**  
1.526 kg/m

**UYARI!** Alüminyum profillerin, yukarıda belirtilen birim ağırlıkları yaklaşık olarak hesaplanmıştır. Gerçek birim ağırlıkları, teslimat sırasında yapılan tartım işlemi sonucuna göre hesaplanacaktır.  
**WARNING!** Above mentioned aluminium profiles unit weights have been theoretically calculated. The actual unit weight will be calculated on delivery to put into the invoicing process.

# Rüzgar Kırıcı (**PİSTONLU**) Aksesuar Seti

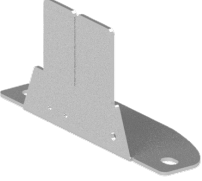
## Accessories

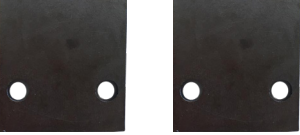
(RKA-SET-1) Aksesuar/Ürün	Açıklama	Birim	Miktar	Kod	
	Üst Hareketli Kapak	Sağ ve Sol Plastik	Adet	2	RKA-201
	Piston Sabitleme Lazeri	Tek Tip Çelik	Adet	2	RKA-212
	Piston	Tek Tip Çelik	Adet	2	RKA-213
	Üst Sabit Kapak	Sağ ve Sol Plastik	Adet	2	RKA-204
	Ayak	Sağ ve Sol Çelik	Adet	2	RKA-205
	Hareketli Kızak	Tek Tip Plastik	Adet	4	RKA-206
	Fren	Tek Tip Çelik	Adet	2	RKA-204

**UYARI!** Alüminyum profillerin, yukarıda belirtilen birim ağırlıkları yaklaşık olarak hesaplanmıştır. Gerçek birim ağırlıkları, teslimat sırasında yapılan tartım işlemi sonucuna göre hesaplanacaktır.  
**WARNING!** Above mentioned aluminium profiles unit weights have been theoretically calculated. The actual unit weight will be calculated on delivery to put into the invoicing process.

# Rüzgar Kırıcı (MOTORLU)

## Windbreaker

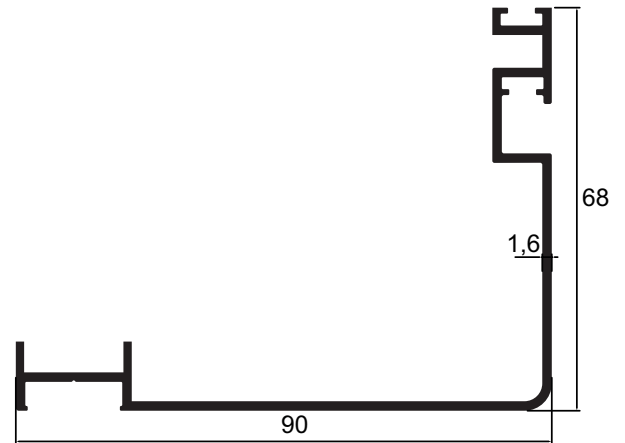
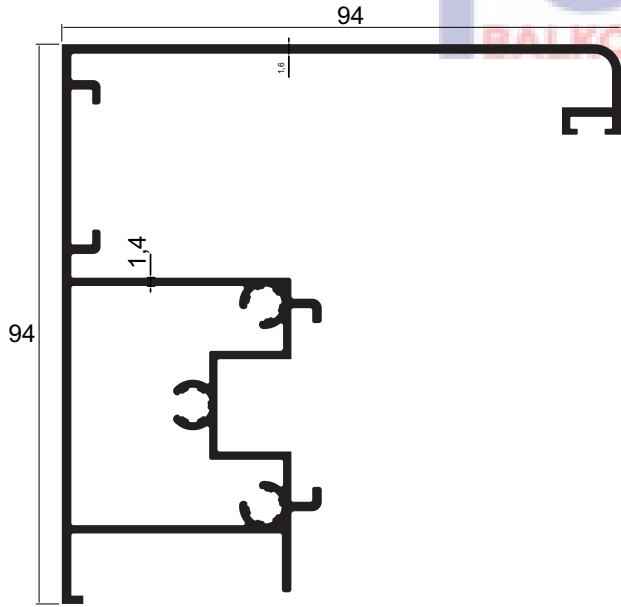
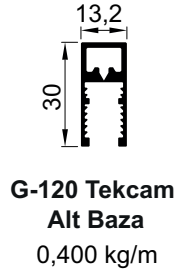
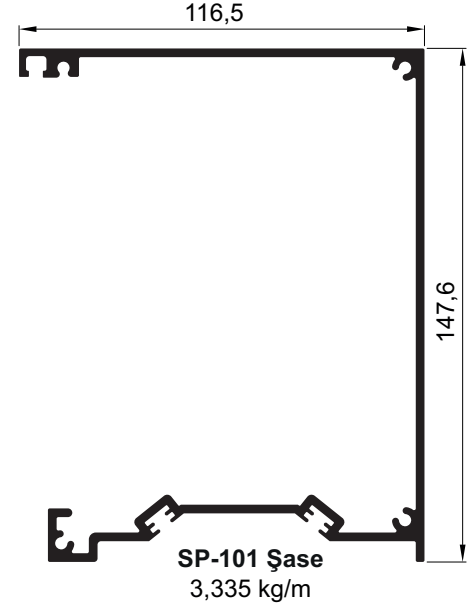
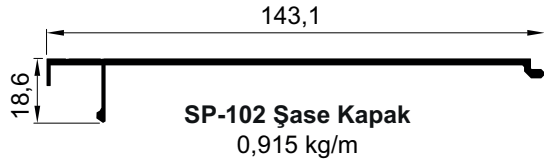

**UYARI!** Alüminyum profillerin, yukarıda belirtilen birim ağırlıkları yaklaşık olarak hesaplanmıştır. Gerçek birim ağırlıkları, teslimat sırasında yapılan tartım işlemi sonucuna göre hesaplanacaktır.  
**WARNING!** Above mentioned aluminium profiles unit weights have been theoretically calculated. The actual unit weight will be calculated on delivery to put into the invoicing process.

# Rüzgar Kırıcı (MOTORLU) Aksesuar Seti

## Accessories

(RKA-SET-3) Aksesuar/Ürün	Açıklama	Birim	Miktar	Kod	
	Rüzgar Kırıcı Makara	Plastik ve Çelik	Adet	2	RKA-15
	Rüzgar Kırıcı Cam Tutucu Vantuz	Tek Tip Plastik	Adet	4	RKA-16
	Rüzgar Kırıcı Cam Tutucu	Tek Tip Çelik	Adet	2	RKA-17
	Dikme Alt Kapak	Sağ ve Sol Plastik	Adet	2	RKA-18
	Dikme Üst Kapak	Sağ ve Sol Çelik	Adet	2	RKA-19
	Rüzgar Kırıcı Cam Kızaklama	Tek Tip Plastik	Adet	2	RKA-20
	Gergi Tamburu	Tek Tip Çelik	Adet	2	RKA-21
	Rüzgar Kırıcı Makara Tablası	Tek Tip Çelik	Adet	2	RKA-22
	Kayış Tamburu	Tek Tip plastik	Adet	2	GA-12
	Boru Başı	Tek Tip Alüminyum	Adet	1	GA-04
	Şase Kapak	Sağ ve Sol Plastik	Adet	2	GA-05
	Şase Kapak Rulman Yatak	Rulmanlı Plastik	Adet	1	GA-06
	Ayak	Sağ ve Sol Çelik	Adet	2	RKA-23